



# 48V ETHOS USER MANUAL



Version 1.5

SCAN THE QR CODE FOR  
THE LATEST VERSION



© 2024 BIGBATTERY, INC. ALL RIGHTS RESERVED  
VERSION 1.5 | INFORMATION SUBJECT TO CHANGE WITHOUT NOTICE  
MODEL SKU: FETHS-48051-G1

## VERSION HISTORY

Edition	Date	Chapters	Reason for Change
1.1	12/13/2023	All	Manual development
1.2	12/19/2023	3.1 & 3.2	Connections
1.3	12/20/2023	5.2	Product Specifications
1.4	01/23/2024	All	Minor fixes
1.5	02/28/2024	All	Product Specifications

# Table of Contents

---

1. Definition of Terms.....	4
2. Safety Instructions.....	5
3. Introduction.....	7
3.1 Product Description.....	7
3.2 Features & Applications.....	8
4. Packed Components.....	8
4.1 ETHOS Battery Module.....	8
4.2 ETHOS Control Box.....	9
4.3 ETHOS Battery Final Module Power Cable.....	9
4.4 ETHOS Parallel Kit.....	10
4.5 ETHOS Battery System.....	10
5. Product Specifications.....	12
5.1 ETHOS Overview.....	12
5.2 ETHOS System Specs.....	13
5.3 ETHOS Diagram.....	15
5.4 ID Addresses Description.....	16
5.5 Communication Ports Description.....	17
5.6 Battery LED Indicators.....	17
6. Installation.....	18
6.1 Installation Safety Guidelines.....	18
6.2 Installation Requirements.....	18
6.3 ETHOS System Installation.....	19
6.3.1 ETHOS System Mounting.....	19
6.3.2 ETHOS System Connections.....	21

- 6.4 ETHOS System Wiring Connection Diagrams..... 24
  - 6.4.1 10kWh System..... 24
  - 6.4.2 15kWh System..... 25
  - 6.4.3 20kWh System..... 26
  - 6.4.4 30kWh System..... 27
- 6.5 Installation with EG4 18kPV Hybrid Inverter.....28
- 7. Battery Commissioning..... 30
  - 7.1 Screen Navigation and Protocol Selection..... 30
  - 7.2 Supported Inverters.....33
- 8. Battery Operation Guide..... 33
  - 8.1 Charging..... 33
  - 8.2 Discharging..... 34
  - 8.3 State of Charge..... 34
  - 8.4 Storage..... 35
  - 8.5 Extend the life of your Battery..... 35
- 9. Service..... 36
  - 9.1 Troubleshooting..... 36
  - 9.2 Maintenance..... 37
  - 9.3 Monitoring Software.....38
- 10. Recycling..... 41
- 11. Warranty & Returns..... 41



# 1. Definition of Terms

---

- AWG – American Wire Gauge
- A – Amp(s)
- Ah – Amp hour(s)
- AC – Alternating Current
- Battery Module – Single battery
- Battery System – Two or more battery modules connected to a control box
- BMS – Battery Management System
- Capacity – Measure of stored energy, typically in Ah or mAh
- Control Box – Master BMS Unit
- Cell Balancing – Process of ensuring uniform charge among cells in a battery
- Cycle Life – Total charge-discharge cycles before capacity decline
- C-rating – Charging/discharging rate relative to battery capacity
- DC – Direct Current
- DOD – Depth of Discharge
- ESS – Energy Storage System
- kW – Kilowatt
- kWh – Kilowatt-hour
- LFP – Lithium Iron Phosphate or LiFePO<sub>4</sub>
- mm – Millimeter(s)
- mV – Millivolt(s)
- Overcharge – Charging beyond recommended voltage limits
- PPE – Personal Protective Equipment
- PV – Photovoltaic
- Self-Discharge – Natural battery discharge over time
- State of Charge (SOC) – Battery's remaining charge as a percentage
- State of Health (SOH) – Overall battery condition and performance
- Thermal Runaway – Dangerous overheating with potential battery damage
- V – Volt(s)











## 2. Safety Instructions

Before you start working, make sure to read and follow all safety instructions for handling the battery. When installing it, be sure to meet all the rules and regulations in your area. Ask your local authority for the right permits and approvals before you install it.



















Lithium Iron Phosphate (LiFePO<sub>4</sub>) batteries are an inherently safe chemistry. However, safety measures should always be taken as consideration before, during, and after installation and during ongoing use and maintenance. The following safety notices are crucial for both the installer and end users when operating this product normally.

**Improper installation could result in harm to the installer, the operator, or others, as well as damage to the battery or connected equipment.**

### WARNING:

-  Do not make any connections or disconnections to the system when the batteries are in operation. Working with active batteries can lead to system component damage or pose a risk of electrical shock.
-  Do not charge with a charge voltage above 58.8V.
-  Do not charge nor discharge battery when ambient temperature is above **55 °C** (**131 °F**).
-  Do not install battery where it may contact conductive materials, water, seawater, strong oxidizers, nor strong acids.
-  Do not install battery in a location exposed to direct sun, hot surfaces, nor hot locations. Do not install batteries in a tight clearance compartment, overheating may result.
-  Keep any flammable/combustible material (e.g. paper, cloth, plastic, etc.) that may be ignited by heat, sparks, flames, or any other heat source at a minimum distance of two feet away from the batteries.
-  Disconnect batteries immediately if, during operation or charging, they emit an unusual smell, develop heat, or behave abnormally.
-  Have a Class ABC or Class BC fire extinguisher on the premises.
-  Never short-circuit DC inputs: may result in a risk of electric shock or fire.
-  Do not disassemble the battery: Contact BigBattery for proper handling instructions. Incorrect servicing or re-assembly may result in a risk of electric shock or fire and voiding the warranty

**PRECAUTION:**

-  Qualified personnel must handle all product work to reduce the risk of electric shock.
-  Follow local and national electrical standards for installation and confirm utility provider and local authorities requirements before grid connection.
-  Maintain visibility of warning labels and nameplates.
-  Choose battery placement with future user safety in mind.
-  Keep children away from the battery and systems.
-  Use team lift technique due to battery weight.
-  Use batteries as directed; do not open or modify.
-  Avoid inserting foreign objects into battery terminals.
-  Handle batteries and/or battery-powered devices cautiously when using metal tools or when around the system. Risk of electrical arcs or short-circuits can cause serious harm, death, and equipment damage.
-  Do not charge battery if ambient temperature is below **0 °C (32 °F)**, nor discharge battery if ambient temperature is below **-20 °C (-4 °F)**.
-  Beware of the battery current: Please ensure that the battery is “off” before installing or working on the battery. Use a voltmeter to confirm there is no voltage present.
-  Always wear protective gear when handling batteries (PPE).
-  Handle batteries carefully to prevent damage; avoid pulling, dragging, or mishandling.
-  Inspect batteries before use; don't use damaged or swollen ones; contact BigBattery immediately.
-  Don't paint any part of the batteries, inside or out.
-  Make sure all cable connections are properly tightened and secured, and to prevent any accident caused by improper installation.
-  Install and remove batteries using the handles provided.
-  Do not place any objects on top of batteries.
-  Before storing battery for more than 6 months, fully charge the battery and disconnect batteries from your system.

**Disclaimer:**

*BigBattery, Inc has the authority to modify the content here without prior notice. To access the latest manual version, please visit our website at [www.bigbattery.com](http://www.bigbattery.com).*

## 3. Introduction

---

Introducing BigBattery's ETHOS! These revolutionary stackable on-grid lithium battery systems designed to push the boundaries of efficiency, flexibility, and reliability in energy management are the BEST Batteries Money can Buy. The ETHOS represents a leap forward in energy storage technology, offering a compact and scalable solution for seamlessly integrating renewable energy sources into your home or business. With its cutting-edge features and intelligent design, this advanced lithium battery system promises to empower individuals and organizations to take control of their energy usage like never before. Equipped with one of our ETHOS battery systems from BigBattery, you'll stay powered and prepared!

This User Manual is designed to provide you with an understanding of the specs, features, capabilities, and installation of these batteries. Read and take note of all safety information prior to installing or operating your battery. This document applies to every ETHOS stackable battery system.

### 3.1 Product Description

---

The 48V 5kWh ETHOS stackable battery systems are ideal for low-voltage residential (grid-tied homes), solar systems, off-grid power systems, emergency power supplies, and more. Each single battery module is 51.2V 100Ah and it can be expanded from 5kWh up to 80 kWh per control box. These batteries utilize lithium iron phosphate (LiFePO<sub>4</sub> or LFP) cells, renowned for their top-notch safety.

They are equipped with an intelligent Battery Management System (BMS) that continuously monitors and records cell voltage, along with real-time data on current, voltage, and temperature for the module. The BMS features a passive balance function and an advanced battery control method, which collectively enhance battery pack performance. Furthermore, the battery includes built-in fire-extinguishing modules for added safety. The battery Utilizes standardized Amphenol UL ESS Connector, which easily and safely secures power to your battery unit. Designed to endure, the ETHOS has a lifespan of over 10 years and is engineered to withstand more than 4000 - 8000 cycles at 80% Depth of Discharge (DOD) at a rate of 0.5C.

You can always monitor your battery's health and performance from the LED interface located on the control box, which will display BMS status codes alerting you to the condition of your battery.

## 3.2 Features & Applications

### Applications:

- Residential
- Commercial
- Grid-Tied Homes
- Cabin Off-Grid
- ESS
- Backup Power

### Features:

- Advanced BMS (Battery Management System)
- Lithium-Ion LiFePO4/LFP Chemistry
- Easy connection to a larger power system
- Expandable system with its modular stackability
- Multiple layers of safety and battery protection
- Built-in fire suppression system
- Good insulation performance
- Utilizes standardized Amphenol UL ESS Connector
- Smart Control Box
- LED Smart Monitor Display
- Parallel Communication
- CAN bus and RS-485 communication with different inverters.
- RJ-45 ports
- Hidden cables for better presentation

## 4. Packed Components

---

### 4.1 ETHOS Battery Module

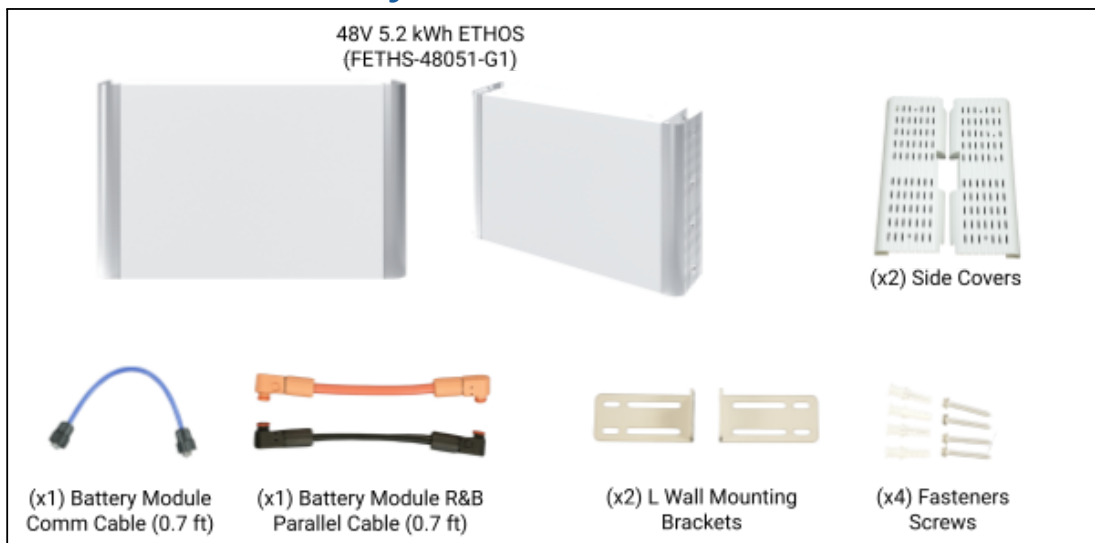

## 4.2 ETHOS Control Box



## 4.3 ETHOS Battery Final Module Power Cable

The ETHOS Battery Final Module to Control Box Power Cable Pair connects the furthest battery module to the Control Box. This cable serves two main purposes: redundancy and completing the loop for parallel connections in both the 10kWh system (with 2 Modules) and the 15kWh system (with 3 Modules). See section 6.41 and 6.4.2 for more information.

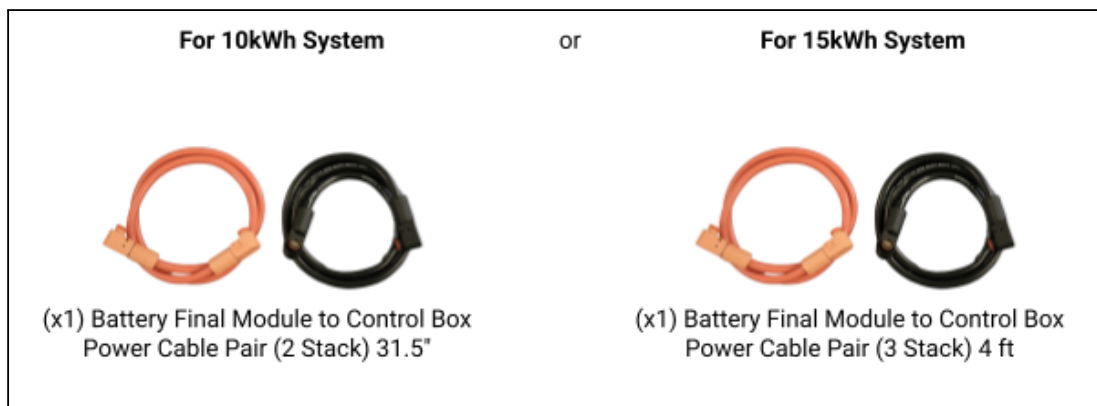

## 4.4 ETHOS Parallel Kit



*The ETHOS Parallel Kit allows the system to expand from 15kWh up to 76.8kWh. Each Parallel Kit will allow you to add one more stack per kit.*

## 4.5 ETHOS Battery System





*The ETHOS Battery System can connect up to 15 batteries for a Total of 76.8 kWh.*



## 5. Product Specifications

### 5.1 ETHOS Overview

**Figure 1: ETHOS Battery and Control Box Overview**

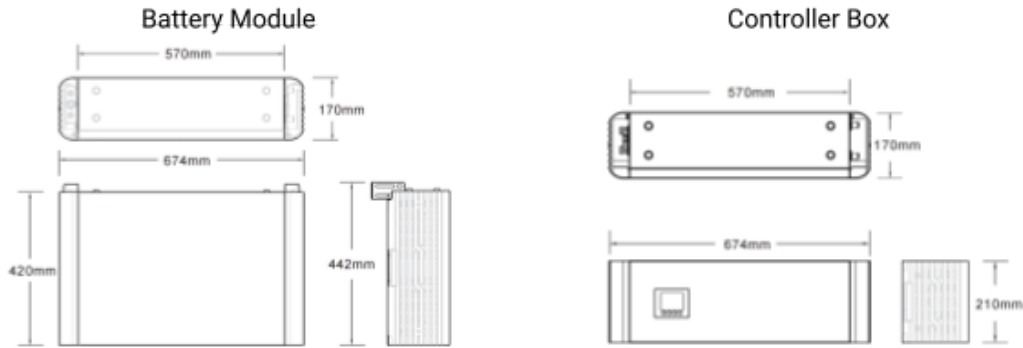

**Figure 2: ETHOS System Overview**

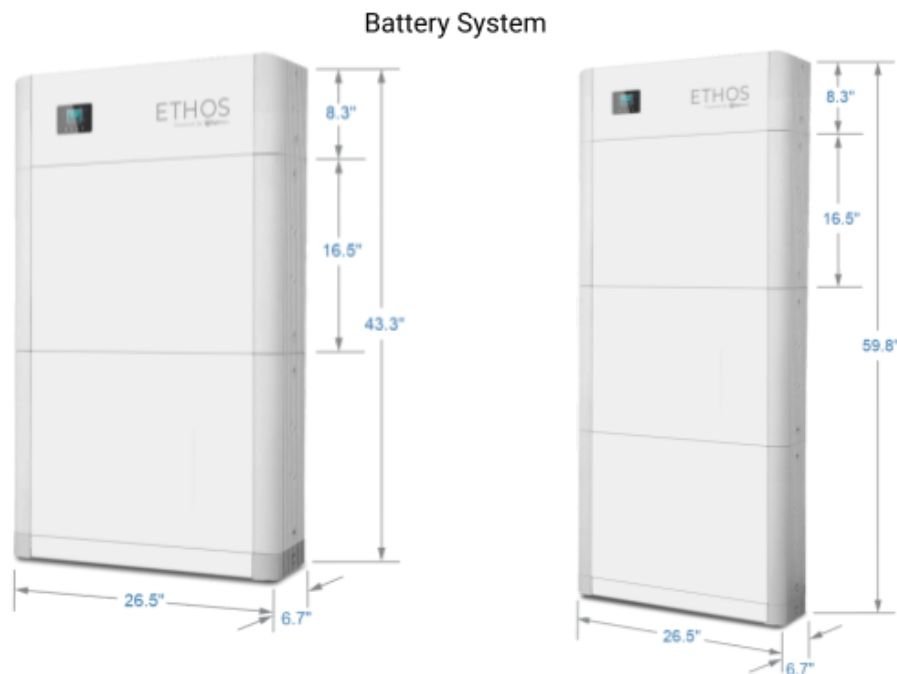

*Before handling the battery, always switch it off and verify there is no voltage with a voltmeter to prevent accidental contact with live terminals. Failure to do so could lead to severe injury or fatality.*

## 5.2 ETHOS System Specs

### BATTERY SPECIFICATIONS

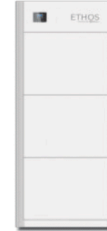

SKU	KIT0949	KIT0950
System Voltage	48V	48V
Nominal Voltage	51.2V	51.2V
Chemistry	LiFePO4	LiFePO4
kWh Capacity	10.24 kWh	15.36 kWh
Ah Capacity	200 Ah	300 Ah
Charging Voltage Range	55.6V - 57V	55.6V - 57V
Max Charge Voltage	58.8V	58.8V
Operating Voltage Range	48V - 57V	48V - 57V
Suggested Low Voltage Cutoff	48V - 50.8V	48V - 50.8V
Cell Configuration	16S 2P	16S 3P
Max Continuous Discharge Current	200A	250A
Max Continuous Power	10240W	12800W
Max Discharge Peak Current	300A (Max 5 seconds)	300A (Max 5 seconds)
Max Charge Current	200A	200A
Charge Temperature Range	32°F - 113°F (0°C - 45°C)	32°F - 113°F (0°C - 45°C)
Discharge Temperature Range	-4°F - 140°F (-20°C - 60°C)	-4°F - 140°F (-20°C - 60°C)
Optimal Discharge Temperature Range	59°F - 95°F (15°C - 35°C)	59°F - 95°F (15°C - 35°C)
Storage Temperature Range (SoC >50%)	-4°F - 113°F (-20°C - 45°C) (Max 6 months)	-4°F - 113°F (-20°C - 45°C) (Max 6 months)
Dimensions (DxWxH)	6.7 x 26.5 x 43.3 in (170 x 674 x 1100 mm)	6.7 x 26.5 x 59.8 in (170 x 674 x 1520 mm)
Weight	273 lbs (123.8 kg)	387 lbs (175.5 kg)
Max Connections	Up to (16) parallel connections per control box	Up to (16) parallel connections per control box
Communications	CANBus / RS485	CANBus / RS485
Protection Rating	IP65	IP65
Certifications	UL9540, UL9540a, UL1973, & UN38.3	UL9540, UL9540a, UL1973, & UN38.3

## BATTERY SPECIFICATIONS



SKU	KIT0951	KIT0953
System Voltage	48V	48V
Nominal Voltage	51.2V	51.2V
Chemistry	LiFePO4	LiFePO4
kWh Capacity	20.48 kWh	30.72 kWh
Ah Capacity	400 Ah	600 Ah
Charging Voltage Range	55.6V - 57V	55.6V - 57V
Max Charge Voltage	58.8V	58.8V
Operating Voltage Range	48V - 57V	48V - 57V
Suggested Low Voltage Cutoff	48V - 50.8V	48V - 50.8V
Cell Configuration	16S 4P	16S 6P
Max Continuous Discharge Current	250A	250A
Max Continuous Power	12800W	12800W
Max Discharge Peak Current	300A (Max 5 seconds)	300A (Max 5 seconds)
Max Charge Current	200A	200A
Charge Temperature Range	32°F - 113°F (0°C - 45°C)	32°F - 113°F (0°C - 45°C)
Discharge Temperature Range	-4°F - 140°F (-20°C - 60°C)	-4°F - 140°F (-20°C - 60°C)
Optimal Discharge Temperature Range	59°F - 95°F (15°C - 35°C)	59°F - 95°F (15°C - 35°C)
Storage Temperature Range (SoC >50%)	-4°F - 113°F (-20°C - 45°C) (Max 6 months)	-4°F - 113°F (-20°C - 45°C) (Max 6 months)
Dimensions (DxWxH)	6.7 x 53.1 x 43.3 in (170 x 1349 x 1100 mm)	6.7 x 53.1 x 59.8 in (170 x 1349 x 1520 mm)
Weight	513 lbs (232.7 kg)	755 lbs (342.5 kg)
Max Connections	Up to (16) parallel connections per control box	Up to (16) parallel connections per control box
Communications	CANBus / RS485	CANBus / RS485
Protection Rating	IP65	IP65
Certifications	UL9540, UL9540a, UL1973, & UN38.3	UL9540, UL9540a, UL1973, & UN38.3

## 5.3 ETHOS Diagram

### ETHOS Battery

Figure 3: ETHOS Battery Diagram

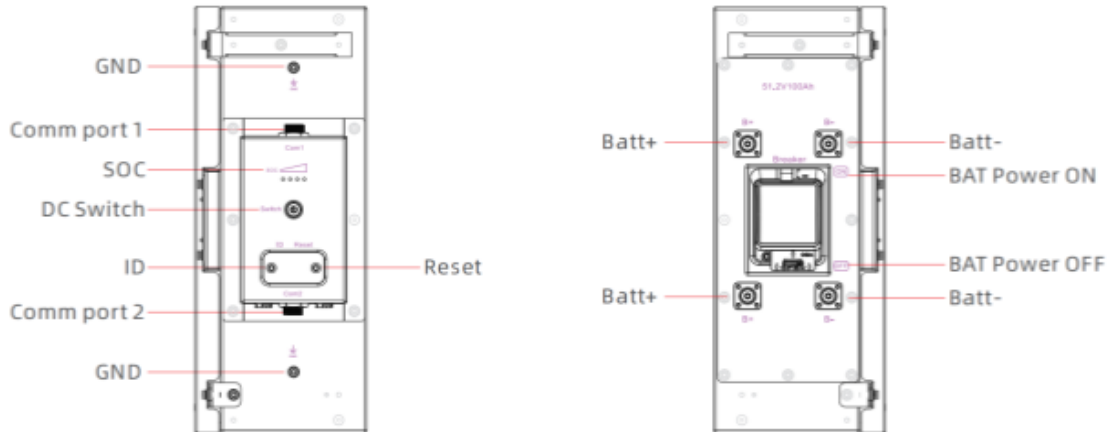

Item	Name	Description	Details
1	GND	Ground Terminal	Screw
2	Comm Port	RJ45 Communication Port	RS485/CAN
3	SOC	Battery State of Charge LEDS Indicators	4 LEDS On = 100% 3 LEDS On = 75% 2 LEDS On = 50% 1 LED On = 25%
4	On/Off Button	Button Switch On/Off the BMS	
5	ID	Battery Communication ID	Dip-Switch
6	Reset	Reset Button	
7	Batt -	Negative Battery Terminal	
8	Batt +	Positive Battery Terminal	
9	Breaker	Batt Power ON/OFF	

## ETHOS Control Box

**Figure 4: ETHOS Control Box Diagram**



Item	Name	Description	Details
1	Inverter -	Negative Inverter Terminal	
2	Inverter +	Positive Inverter Terminal	
3	Batt Comm	RJ45 Communication Port	RS485/CAN
4	Inverter Comm	RJ45 Communication Port	RS485/CAN
5	Breaker	Control Box Power ON/OFF	
6	GND	Ground Connection	
7	Batt -	Negative Battery Terminal	
8	Batt +	Positive Battery Terminal	

## 5.4 ID Addresses Description

**Figure 5: ETHOS Battery ID Description**

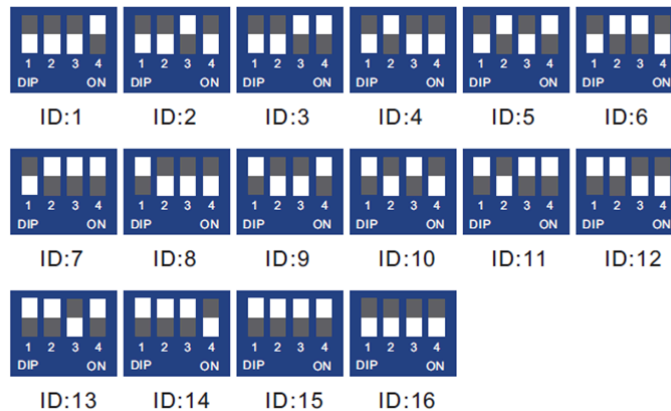

ID code bits correspond to binary digits, down represents "0", up represents "1", the right side of the code bit is the low bit, the left side is the high bit, the code range is 0~15, and the communication mode can support up to 16 modules in parallel. Select the first battery as "0001" (ID:1) and the second as "0010" (ID:2), the third as "0011" (ID:3) and so on making sure every battery has a unique ID.

## 5.5 Communication Ports Description

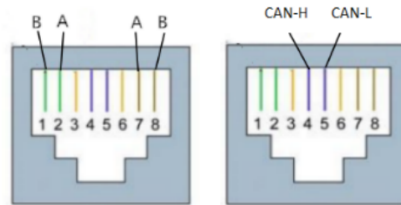

Pin	Description	Pin	Details
1	RS485 B- ( T/R-)	5	CAN-L
2	RS485 A+ ( T/R+)	6	-
3	-	7	RS485 A+ ( T/R+)
4	CAN-H	8	RS485 B- ( T/R-)

**Note:** Both RJ45 Communication Port can be used for RS485 or CAN protocols.

## 5.6 Battery LED Indicators

Each battery module has an SOC light that will tell you the current state of charge of that module according to the table below.

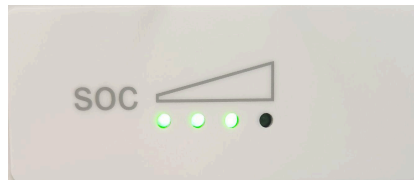

Status	SOC ****
Shutdown / Sleep	OFF
Stand by	4 LEDES On = 100% 3 LEDES On = 75% 2 LEDES On = 50% 1 LED On = 25%
Charge	
Discharge	
Over voltage	All on
Under voltage	All off

**Notes:**

Shutdown: All LED lights are off. Each SOC light represents 25%

## 6. Installation

---



**WARNING:** Before installing, make sure to review all warnings and precautions in Section 2, as well as the installation safety guidelines in Section 6.1 below.

### 6.1 Installation Safety Guidelines

- Inspect batteries upon receipt for any signs of damage before use. In case of battery damage, reach out to BigBattery for repair or replacement. Avoid using a defective battery as it may result in incorrect battery voltage that could potentially ruin your appliances. Damaged batteries have the potential to cause fire hazards.
- Check to ensure that all cables are in good condition.
- Be sure your battery packs are powered “OFF” before making/removing any connections.
- It is crucial to never create a short circuit on the external battery terminals. When attaching the battery, ensure that each cable is properly connected to the correct terminal. There should be no conductive material between the terminals that could cause a short circuit.
- Use a screwdriver with a rubber coated handle.
- **Do not put the ETHOS batteries in series.** The BMS and internal components are not designed to handle this setup, which could cause the modules to fail.
- Always mount the battery in an upright position.

### 6.2 Installation Requirements

The battery cabinet's placement significantly affects safety, longevity, and performance. It should allow for convenient system wiring, maintenance, and operation, while avoiding high-temperature, high-humidity environments. Ensure there's enough space and strong support for the battery. Use cable specifications that match the equipment's maximum current needs. Arrange the power equipment and batteries logically. Keep the wiring neat, moisture-proof, and corrosion-resistant. During installation, wear an anti-static wristband and have at least two people present.

## 6.3 ETHOS System Installation

### 6.3.1 ETHOS System Mounting

①

Install the bottom base on the ground about 1.2 inches (30 mm) from the wall, as shown in figure 5.

**Figure 5: Bottom base installation**

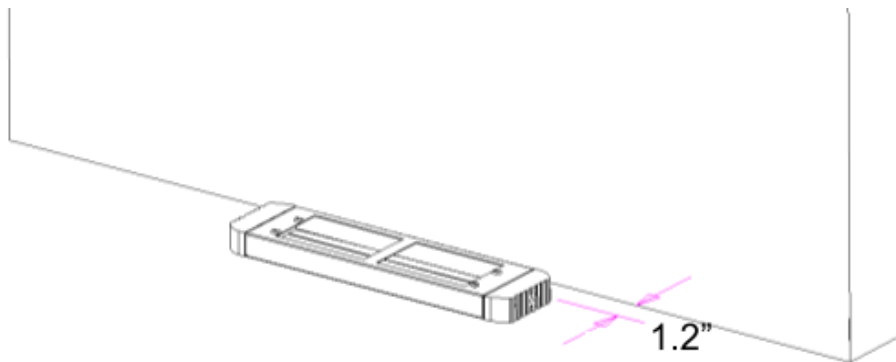

②

Stack up one battery module on top of the bottom base, the side with visible screws should be facing the wall, as illustrated on figure 6.

**Figure 6: Battery module installation**

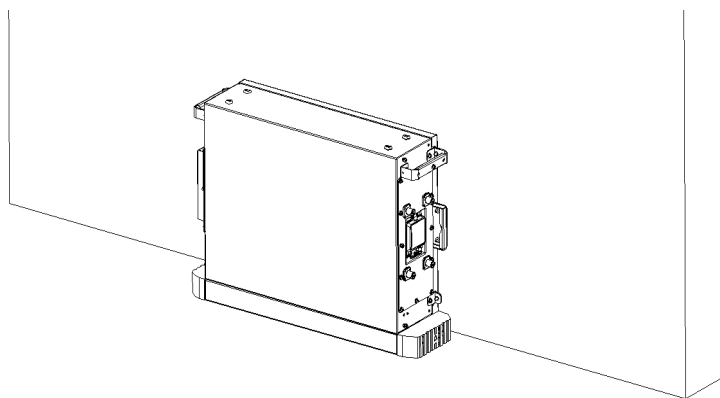



③

Then stack another battery module until three of the battery modules are on top of the bottom base. then add the control box on top. Secure each module to the wall using L brackets and the fastener screws. Refer to figures 7 and 8.

**Figure 7: Control box installation**

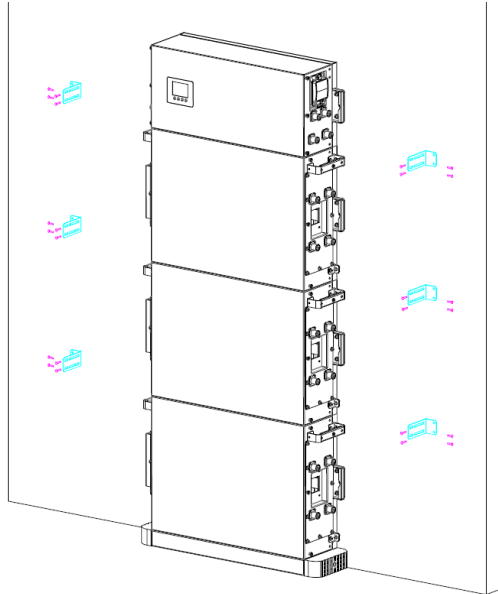

**Figure 8: L bracket installation**

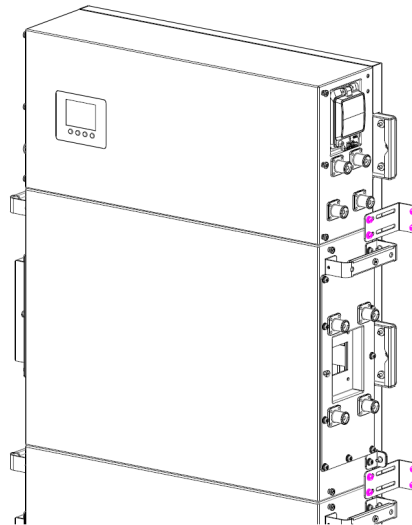

## 6.3.2 ETHOS System Connections

### ① Left side (Comm) connections:

- Use the Battery Module Comm Cable (0.7 ft) to connect the bottom Battery's Module "Com 1" port with the upper battery module "Com 2" port. Continue this sequential connection with all battery modules' communication ports in a daisy chain until you connect the upper battery module "Comm 1" port to the Control Box "Battery comm".
- Finally, set each of the battery module's ID dip switches according to section 5.4. "ID Addresses Description", the first battery module connected directly to the ETHOS control will be set to ID16, the second one will be ID1, the third one ID2, and so on. Make sure every battery has a different and unique ID.

**Figure 9: Communication connection diagram**



*For more installation diagrams of different configurations, see section 6.4.*

② **Right side (Power) connections:**

- First, connect the B+ and B- terminals of the bottom battery module to the B+ and B- terminals of the subsequent battery module using the Battery Module Red & Black Parallel Cable (0.7 ft). Repeat the process until all batteries are connected.
- Second, connect the B+ and B- terminals of the upper battery module to the B+ and B- terminals of the Control Box using the Battery Module Red & Black Parallel Cable (0.7 ft).
- Then, connect the B+ and B- terminals of the bottom battery module to the B+ and B- terminals of the Control Box using the Battery Final Module to Control Box Power Cable Pair (2 Stack or 3 Stack).

**Figure 10: Parallel battery connection diagram**

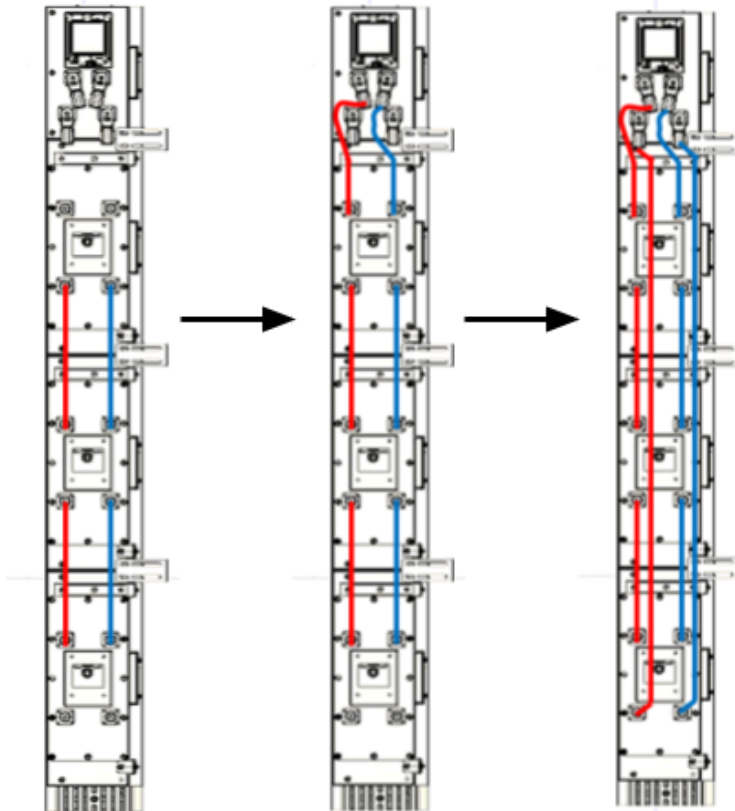

*For more installation diagrams of different configurations, see section 6.4.*

③

Turn on the battery system by pushing in all the power buttons on the left side and making sure the breakers are in the 'on' position on the right side. Check

that the screen on the control box is detecting all the batteries by verifying the amp-hour capacity shown matches the total rated capacity of the system.

④

Finally, attach the side panels to each module and use the secure screws to tight them, as shown in figure 11.

**Figure 11: Side panel installation**

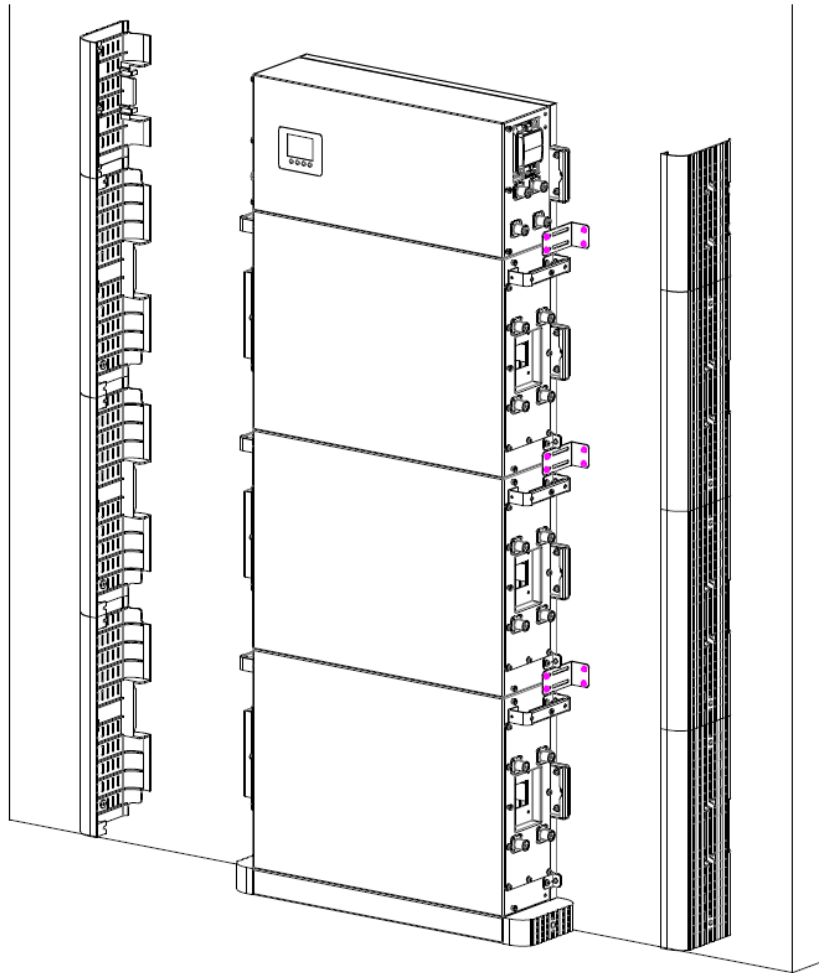

## 6.4 ETHOS System Wiring Connection Diagrams

### 6.4.1 10kWh System

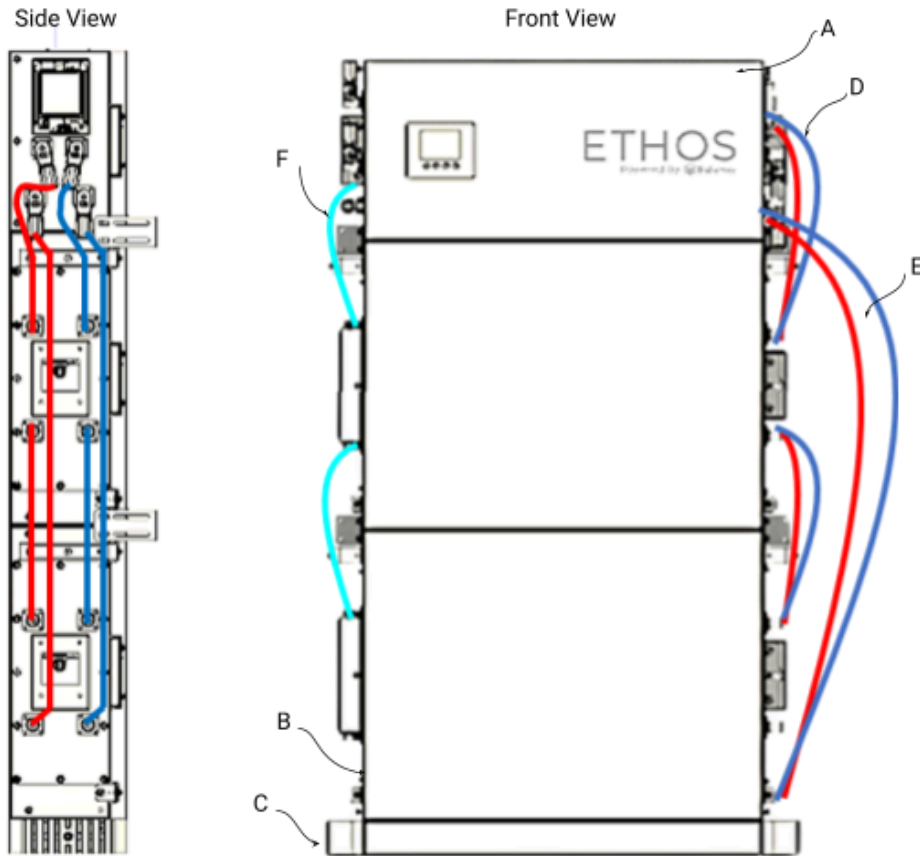

Components shown in the illustration:

- A: (x1) ETHOS Control Box [CNT060]
- B: (x2) 5.12kWh ETHOS Battery Module [FETHS-48051-G1]
- C: (x1) ETHOS BASE
- D: (x2) ETHOS Battery Module Red & Black Parallel Cable (0.7 ft)
- E: (x1) ETHOS Battery Final Module to Control Box Power Cable Pair (2 Stack) 31.5" [CBL088]
- F: (x2) ETHOS Battery Module Comm Cable (0.7 ft)

*Side View is only an illustration of the connections for a better understanding of the install.*

## 6.4.2 15kWh System

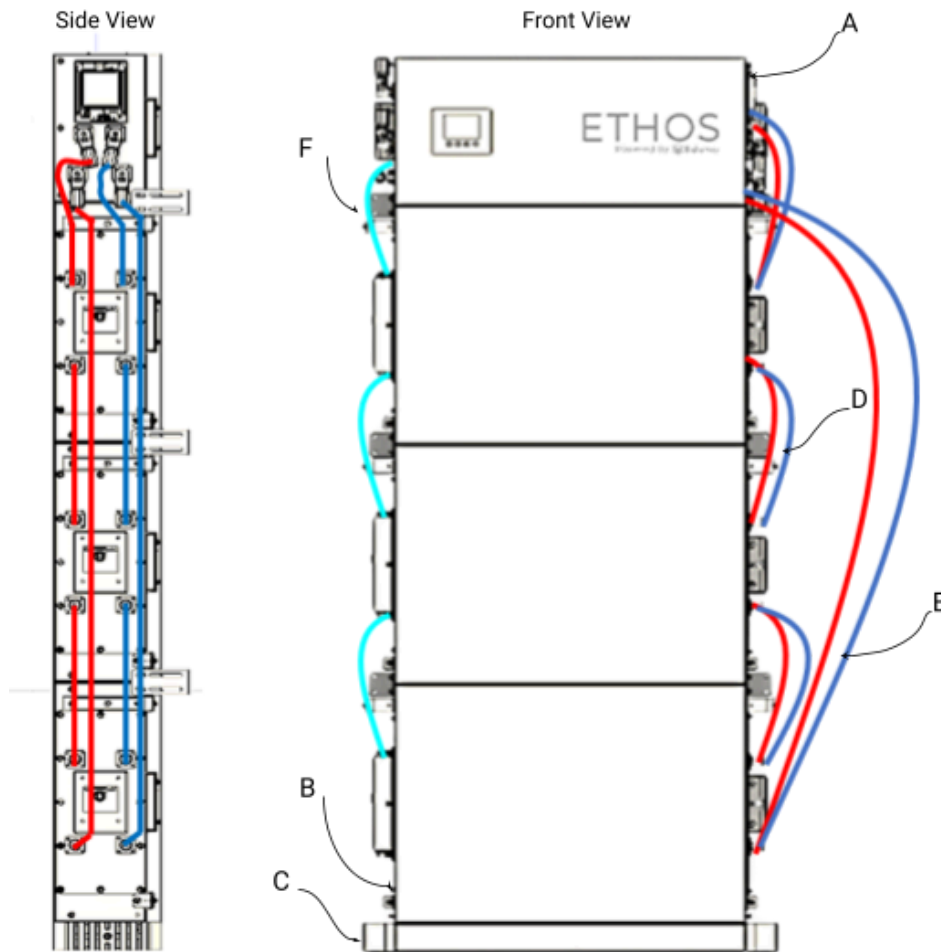

Components shown in the illustration:

- A: (x1) ETHOS Control Box [CNT060]
- B: (x3) 5.12kWh ETHOS Battery Module [FETHS-48051-G1]
- C: (x1) ETHOS BASE
- D: (x3) ETHOS Battery Module Red & Black Parallel Cable (0.7 ft)
- E: (x1) ETHOS Battery Final Module to Control Box Power Cable Pair (3 Stack) 4ft [CBL091]
- F: (x3) ETHOS Battery Module Comm Cable (0.7 ft)

*Side View is only an illustration of the connections for a better understanding of the install.*

### 6.4.3 20kWh System

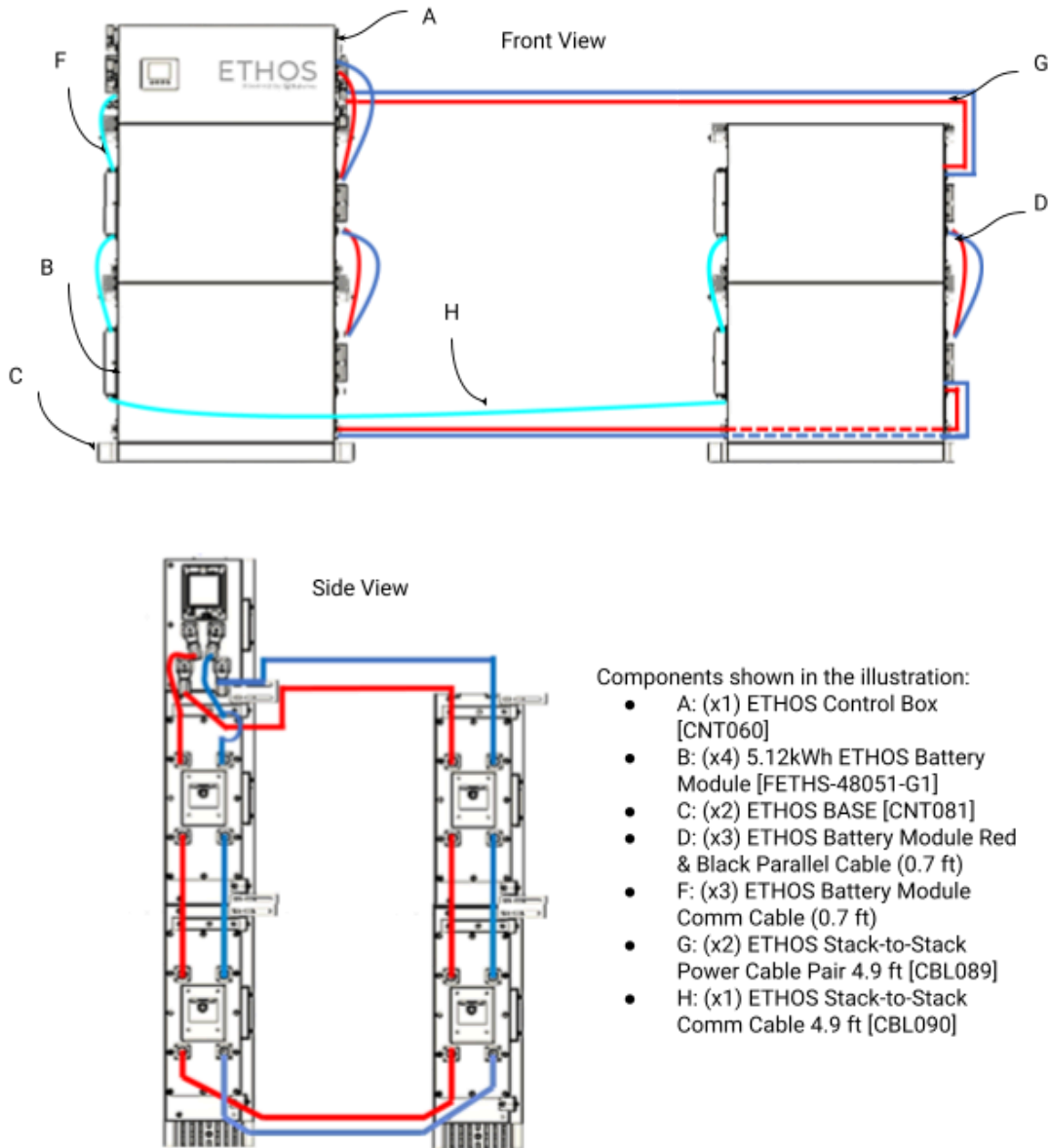

*BigBattery suggests having 12 inches of distance between each ETHOS Stack. Side View is only an illustration of the connections for a better understanding of the install.*

### 6.4.4 30kWh System

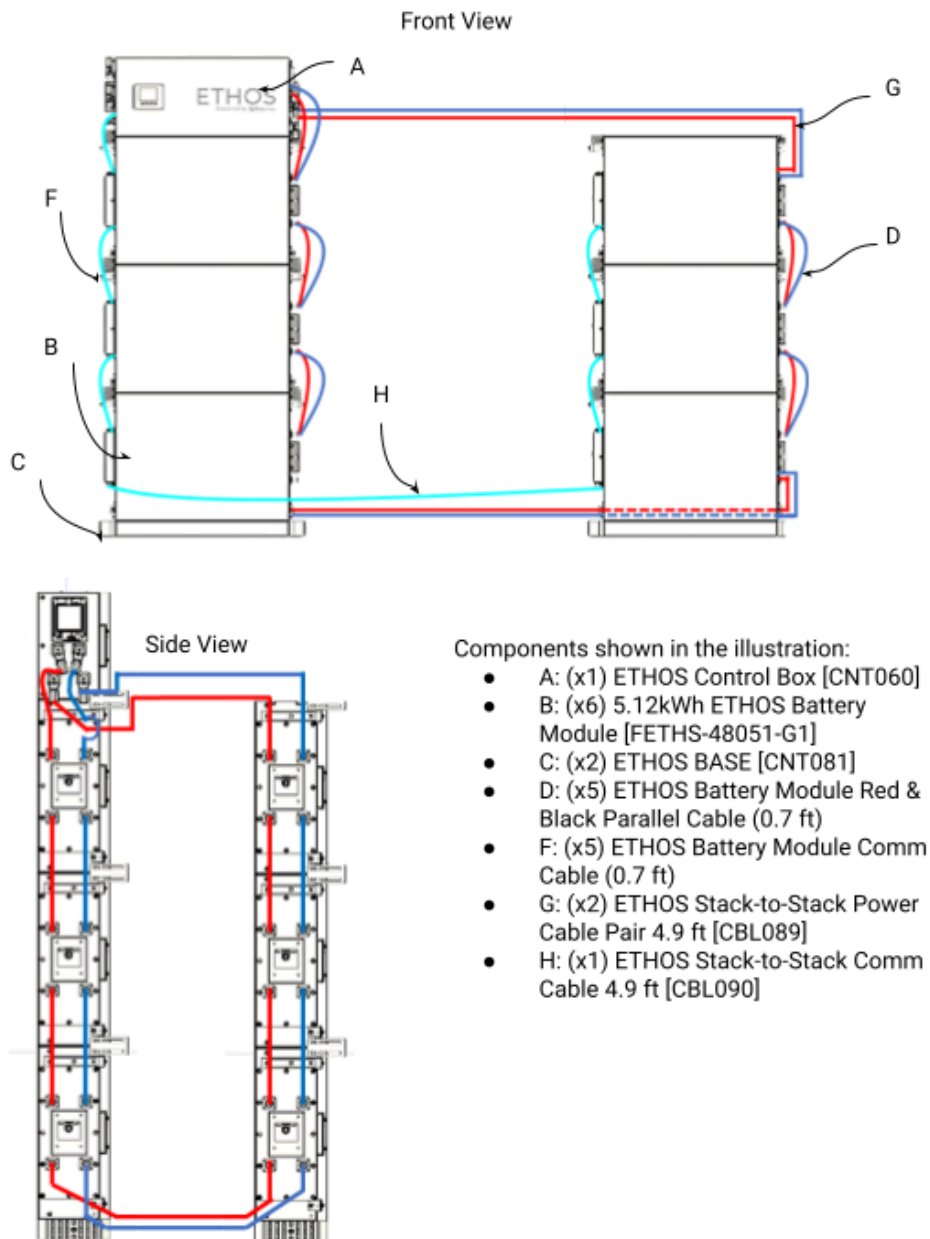

*BigBattery suggests having 12 inches of distance between each ETHOS Stack. Side View is only an illustration of the connections for a better understanding of the install.*



## 6.5 Installation with EG4 18 KPV Hybrid Inverter

See figure 12 & 13 for a wiring diagram between the ETHOS Control box and the EG4 18 KPV Hybrid Inverter. See EG4 18 KPV Hybrid Inverter manual, it will have additional details for set up.

**Figure 12: ETHOS with EG4 18 KPV Hybrid Inverter**

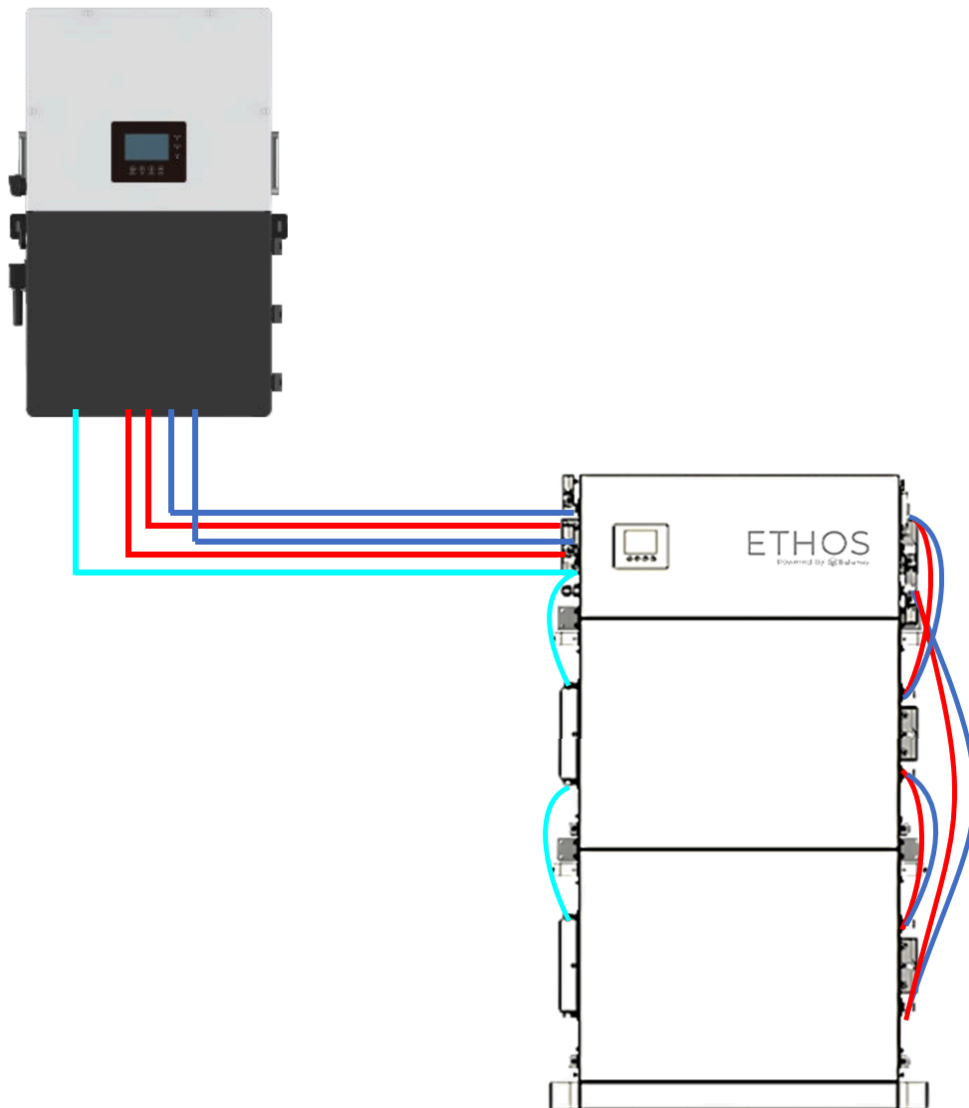

*The EG4 Inverters are compatible with any of the ETHOS System configurations. Figure 12 illustrates the 10kWh ETHOS System and the EG4 18 KPV Hybrid Inverter.*

**Figure 13: ETHOS with EG4 18 KPV Hybrid Inverter Connections**

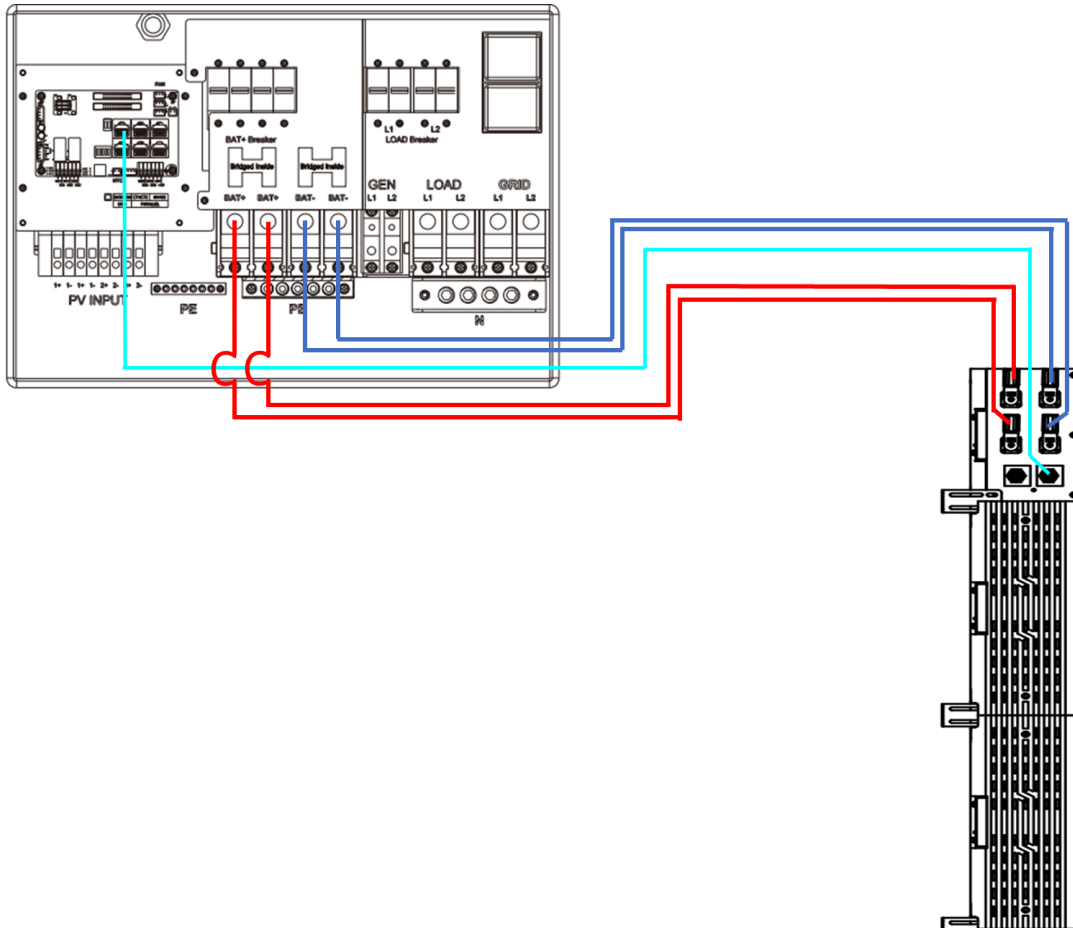

*BigBattery suggests installing the EG4 Inverter at least 12 inches of distance away from the ETHOS System.*

## 7. Battery Commissioning

If the ETHOS battery is connected to an inverter and you want the battery to communicate with the inverter, the battery address and protocol need to be configured through the screen on the control box. If communication is not needed, the battery can be directly connected to the inverter and you would select the Lead-Acid or user-defined configuration on the inverter.

### 7.1 Screen Navigation and Protocol Selection

The LCD display is embedded on the control box, it's used to display information about the battery system, such as voltage, SOC, capacity, running status, etc. It is also used to configure the battery to communicate with a supported inverter.

Press any button to wake up the screen, you should see the BigBattery splash screen for a few seconds and then the home screen shown in figure 14.

**Figure 14: ETHOS home screen**



Press the “BACK” button to access the “About” screen, shown in figure 15, which will display the currently selected RS485/CAN protocol along with the current BMS and screen firmware version. Press “ENTER” to return to the home screen.

**Figure 15: ETHOS about screen**



Hold the "BACK" button for five seconds and release it to enter the "Protocol Setting" menu, shown in figure 16.

**Figure 16: ETHOS protocol setting menu**

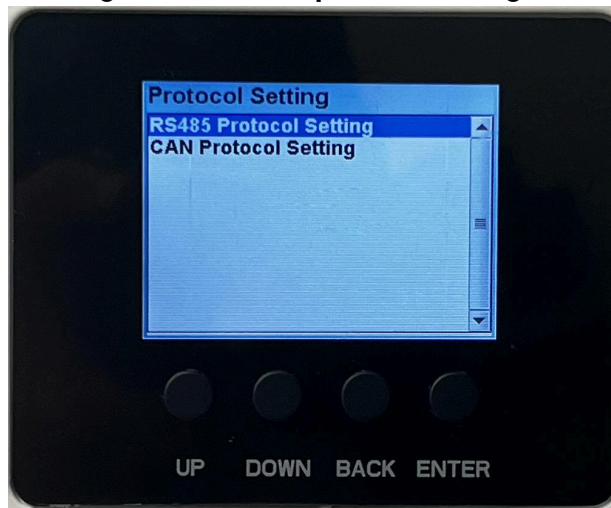

Use the "UP" and "DOWN" buttons to navigate the "Protocol Setting" menu and press "ENTER" to enter either the RS485 or CAN protocol menu, shown in figures 17 and 18

**Figure 17: ETHOS RS485 protocol menu**

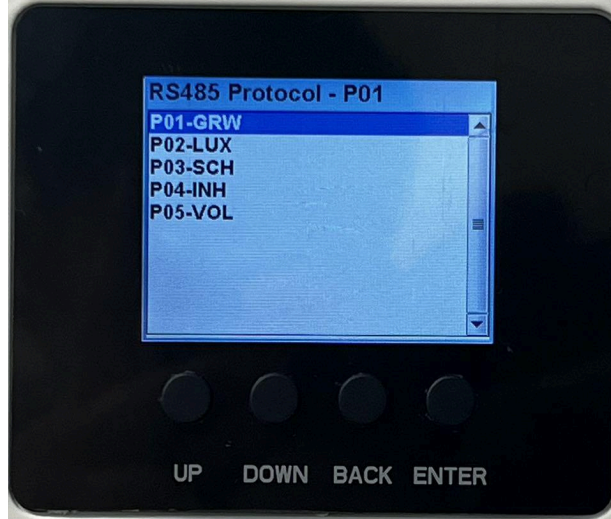

**Figure 18: ETHOS CAN protocol menu**

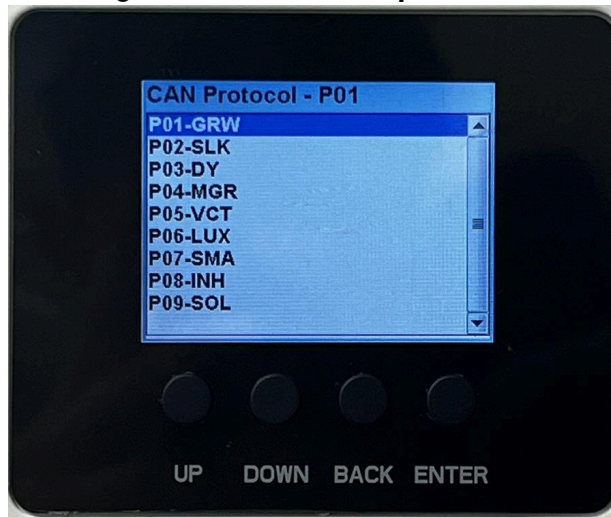

Use the “UP” and “DOWN” buttons to navigate the RS485/CAN protocol menus and press “ENTER” to select the highlighted protocol, the display will then return to the previous screen. See section 7.2. for a list of supported inverters and their associated address. Once the proper protocol has been selected press “BACK” and then power off each battery module using the power button, and then power them back on. Once this is done, the selected protocol will save once the control box is turned back on.

## 7.2 Supported Inverters

P0	RS485	P0	CAN
1	Growatt	1	Growatt
2	EG4	2	Sol-Ark
3	Schneider	3	Deye
4	Inhenergy	4	Megarevo
5	Voltronic	5	Victron
		6	EG4
		7	SMA
		8	Inhenergy
		9	Solis

## 8. Battery Operation Guide

 **WARNING:** Before installing, make sure to review all the parameters listed on chapter 5.2.

### 8.1 Charging

- During the initial charging, monitor the battery's charge voltage to ensure it is within appropriate voltage limits.
- Only use the battery charger provided by BigBattery, or the inverter charging settings listed on section 5.2. Using non-recommended chargers may cause improper charging and damage the battery's capacity.
- The battery cannot be charged in freezing temperatures. When charging is attempted below 0°C / 32°F, the BMS will prevent charging until the battery temperature is above 0°C / 32°F.
- Use LiFePO4 batteries for "opportunity charging." Charge them whenever you can but do it with small amounts of energy. It's better to do this than using fast chargers. Fast charging can make the battery's life shorter.
- It is suggested to charge the battery when it has a minimum of 10-20% SOC. Deep discharge won't harm the battery's health, but the BMS requires some voltage to function properly.

- The Bulk/Absorb Voltage of an LFP battery is the same as the charging voltage. BigBattery products do not need Float Voltage, Equalize voltage or absorption time.

## 8.2 Discharging

- The battery can be fully discharged. Unlike lead-acid batteries, the Voltage of a lithium battery stays very constant during discharge, delivering the same amount of power and energy from 100% to 0% SOC.
- LFP batteries handle discharging to 0% safely, but shallower cycles offer benefits. Opting for 20% SOC, instead of 0%, extends the battery's lifespan to more than 6000 cycles.
- Do not discharge if the temperature is above 55 °C / 131 °F.
- You will see an apparent loss of capacity when discharging at below-freezing temperatures that reverses when the battery gets above freezing.
- The BMS will automatically shut down when the battery reaches a low voltage, so there's no need for manual intervention. Avoid over discharging by removing the load when the battery's discharge is done.

## 8.3 State of Charge

This is the Depth of Discharge of the ETHOS battery:

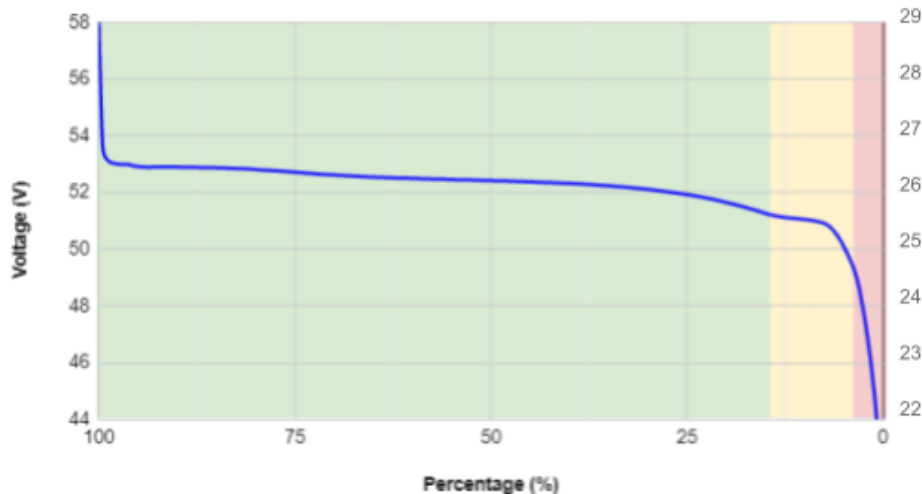

	Cycling in this zone will ensure a reasonable life expectancy
	Occasionally this zone is OK
	Dropping into this zone can lock the battery. Could reduce lifespan.



## 8.4 Storage

- LFP batteries have an extremely low self-discharge rate, which makes long-term storage convenient. Storing a lithium battery for up to a year is not an issue, as long as it has some charge remaining before being placed in storage.
- Before storing lithium-ion batteries, charge them to at least 50% charging level. Do not store batteries that are fully discharged. In the case of a fully charged battery, it should be discharged to 80% before it is stored.
- If you need to store batteries for longer periods, be sure to simply disconnect all wires from them. That way there can not be any stray loads that slowly discharge the batteries.
- Make sure that you store the battery within the temperatures listed on section 5.2. Storing them at low temperatures is certainly much better than storage at high temperatures. The electrolyte in LiFePO4 cells does not contain any water, so even when it freezes it does not expand, and does not damage the cells. Just let the battery warm up a bit before you start discharging it again.

This is the storage temperature that the batteries should be stored, and the charging intervals and methods to do so.

Storage Temperature	Charging Interval	Charging Method
≤20°C	Once / 9M	56V 30A CC/CV Charging to 56V, cut-off current: 5A
20°C~30°C	Once / 6M	
30°C~40°C	Once / 3M	

## 8.5 Extend the life of your Battery

The ETHOS Battery is designed 10 years or more when used correctly. To ensure a proper battery operation, you must follow the previous listed instructions and battery parameters. In order to extend the lifespan of your battery, follow these recommendations.

- Avoid discharging the battery more than 80% Depth of Discharge (DOD) unless it is truly necessary.
- Keep the battery temperature under 95 °F (35 °C) and above 59 °F (15 °C)



- Keep battery charge and discharge current under 0.5 of the Capacity (C-rating)
- Never disassemble the battery, unless our tech support guides you. If the battery has any problems, contact us for assistance.
- Keep the battery away from excessive physical shocks or vibration. These can damage the battery's internal structure and hamper its operation.
- Dirty battery terminals can lead to improper flow of current during operation. Therefore, it is recommended that you clean the terminals while installing the battery pack.

## 9. Service

### 9.1 Troubleshooting

If the battery enters a protection state you will see that the status shows "Protection". In order to get more detailed information you can access the BMS through the "BMS\_TOOLS" software detailed in section 9.3.

No.	Error	Description	Solution
1	Communication failure with inverter	Communication port connection error or battery ID setting error	Check connection. Refer Chapter 7. Battery Commissioning
2	No DC output	Battery is off or low voltage	Turn ON or charge the battery
3	Power supply time is too short	Battery capacity lack or not fully charged	Fully Charge the battery. Maintenance or replacement
4	Battery can't be charged fully	Power system DC output voltage falls below the minimum charge voltage	Change the DC output voltage of the power supply to a suitable charging voltage for the battery
6	The battery output voltage is unstable	Battery management system does not operate normally	Press the switch to restart the battery
7	The charge and discharge capacity is insufficient	Unbalanced cell voltage	Examine/balance the cell
8	Unable to charge and discharge	BMS or cell/temperature sensor damaged	Maintenance or replacement
9	Different SOC value of batteries in parallel	Normal phenomenon	No operation

10	Protection status	Current Protection	Charging or Discharging Current is too high and needs to be reduced
11	Protection status	Over Temperature	Turn off the battery and cool down the location of the battery.
12	Protection status	Under Voltage	Charge the battery
13	Protection status	Over Voltage	Discharge battery, lower charge settings on charger/inverter

## 9.2 Maintenance

Item	Maintenance	Maintenance Intervals
Power Cables	Check whether there is mechanical damage to the power cable and whether the terminal insulation sleeve has fallen off; if there is such a phenomenon, please turn off the machine and carry out maintenance or replacement	Once every 6 months
	check whether the power cable is loose; if there is any sign of looseness, please use a standard torque wrench to tighten it	
	check the system for loose screws or discoloration of the copper bus bar; if the screws are loose, please tighten them with a standard torque wrench; if the copper bus bar is discolored, please contact the manufacturer for after-sales replacement	
Comm Cables	check whether the parallel communication cable terminal is loose, if it is loose, re-tighten it	Once a year
	check whether the color of the communication cable has obvious discoloration, if discoloration, please shut down the machine to replace the communication cable	
Cabinet	Check the cleanliness of the front door, back door and battery module inside the cabinet, if there is obvious dust, please clean up in time.	Once 6-12 months
System Running Status	check if all parameters are normal when the system is running (voltage, current, temperature, etc.)	Once every 6 months
	check whether the main core components of the system are normal, including system switches, contactors, etc. are normal	
	check whether the system air inlet and outlet, air ducts are normal, if there is blockage and congestion, need to clean up in time	

Charge and Discharge Maintenance	Use light load and shallow charge/discharge to check whether the SOC, SOH status of the battery is normal (using the upper computer software to read); it is recommended that the depth of discharge and charge/discharge power should not exceed 20% of the rated value	Once every 6 months
----------------------------------	--	---------------------

## 9.3 Monitoring Software

In order to view real-time detail of the BMS and see historical data you can use the provided battery monitoring software and follow the steps below.

### You will need the following items:

1. (1) Laptop with a USB interface
2. (1) USB to RS-485 communication cable wired according to section 5.5
3. BMS monitoring software (BMS\_TOOLS)

### How to connect to the battery:

- ① Download the BMS-TOOLS folder onto the laptop.
- ② Turn off the battery that you want to monitor and set the ID to 16 (all switched on). Once set, turn the battery on.
- ③ Connect the RS-485 end of the communication cable to the “Com 1” port of the battery you want to monitor, and connect the USB end to your laptop. Check your laptop's device manager to validate that the COM port is detected.
- ④ Open the “ BMS\_TOOLS ” application which is located in BMS-TOOLS > BIN > BMS\_TOOLS.exe. You will then see the screen shown in figure 19.

**Figure 19: BMS Tools unconnected screen**

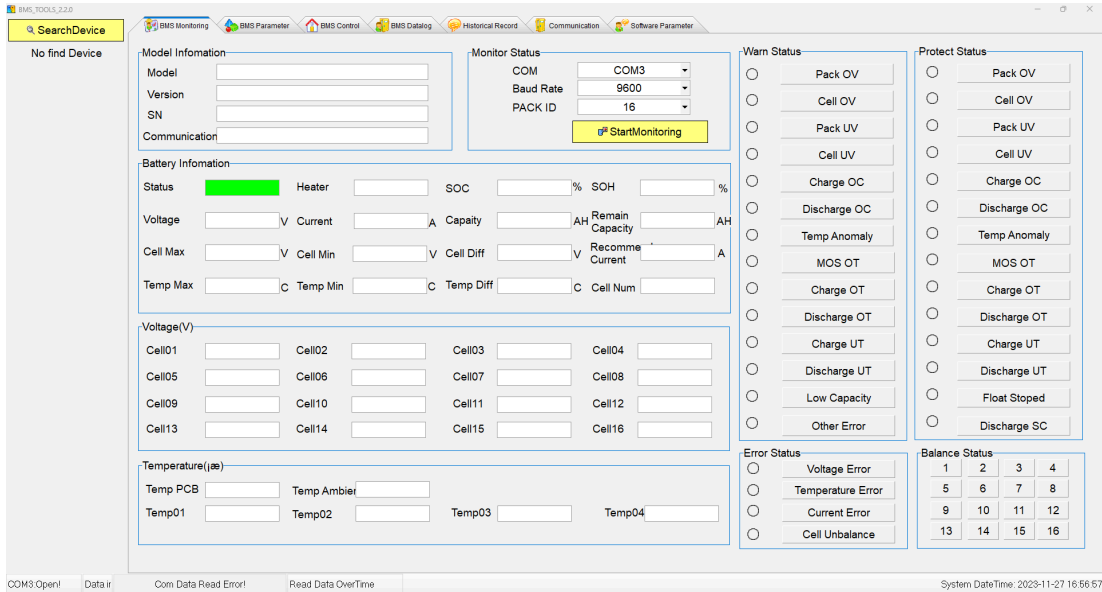

- ⑤ Under “Monitor Status” make sure that the correct COM port is selected, baud Rate is set to 9600, and that “PACK ID” is set to 16” as shown in figure 20.

**Figure 20: BMS Tools Monitor Status**

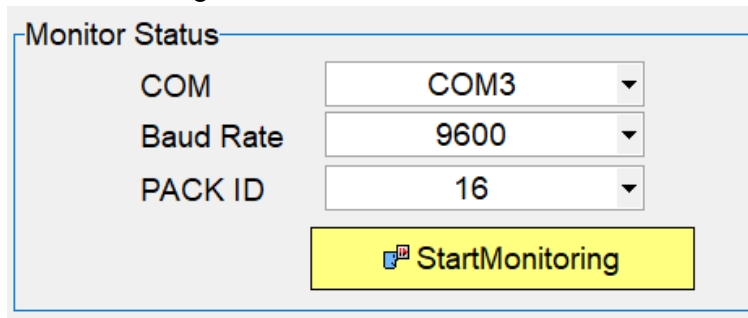

- ⑥ Click “SearchDevice” and let the loading bar complete, once it does you should see the detected battery as shown in figure 21.

**Figure 21: Detected devices**

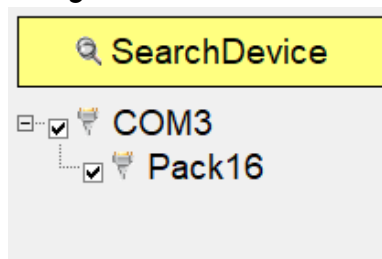

The BMS data will now populate as shown in figure 22. From this point you can see real time data from your BMS and view historical data.

**Figure 22: BMS Tools connected screen**

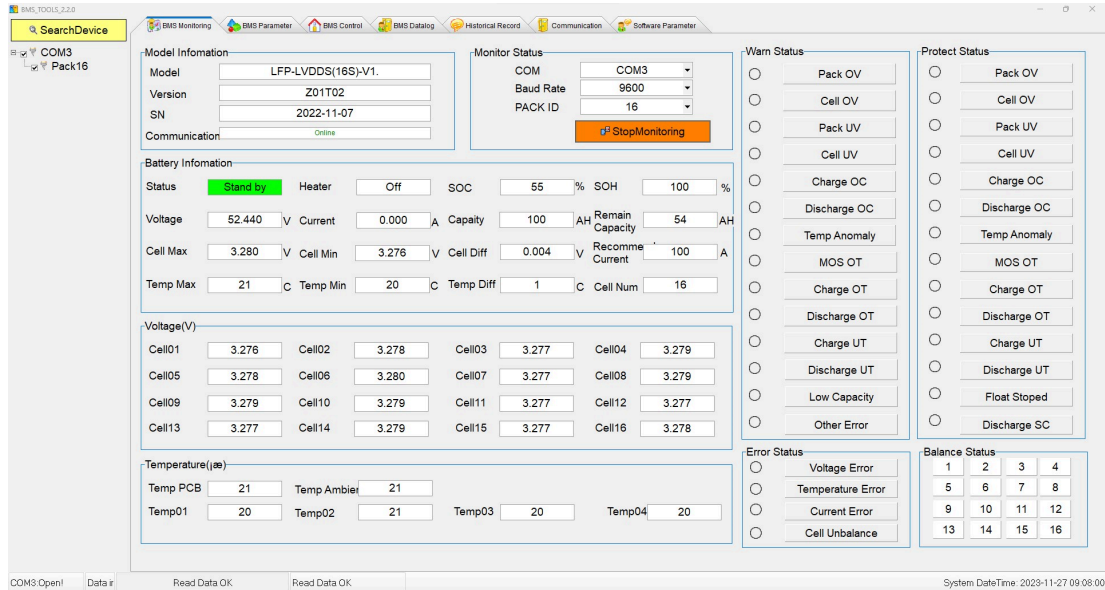

## 10. Recycling

Lithium iron phosphate batteries are potentially dangerous and shouldn't be tossed in the trash. Many websites and organizations can recycle them for free. If you're in the U.S. or anywhere globally, search for "Lithium Battery Disposal Near Me" online. Numerous places can safely dispose of these batteries. Make sure to call first to confirm they're open.

If you can't find a safe disposal option, contact our customer service team instead of improperly disposing of the battery. We'll take care of recycling the batteries for you.

## 11. Warranty & Returns

---

In the unlikely event you are having an issue with one of our batteries we have developed a straightforward warranty & return policy which is detailed in the following link:

[https://bigbattery.com/policies/?gad\\_source=1&gclid=CjwKCAiA6KWvBhAREiwAFPZM7viG8eXNc1fNpm99vxwVI\\_ptHceLQp0xSAZyxsQD0iizXRI4kTa8ARoCPLgQAvD\\_BwE#warranty](https://bigbattery.com/policies/?gad_source=1&gclid=CjwKCAiA6KWvBhAREiwAFPZM7viG8eXNc1fNpm99vxwVI_ptHceLQp0xSAZyxsQD0iizXRI4kTa8ARoCPLgQAvD_BwE#warranty)

For more information and support please visit our website and reach us at:

**BigBattery Inc.**  
**Technical Support Team**  
support@bigbattery.com  
(818) 280-3091, ext. 1005  
9667 Owensmouth Ave., Suite 105  
Chatsworth, California 91311

© 2024 BIGBATTERY, INC. ALL RIGHTS RESERVED  
VERSION 1.5 | INFORMATION SUBJECT TO CHANGE WITHOUT NOTICE  
MODEL SKU: FETHS-48051-G1