



Download  
Manual



🔍 Growatt New Energy

Shenzhen Growatt New Energy Co., Ltd  
4-13/F, Building A, Sino-German (Europe) Industrial Park,  
Hangcheng Ave, Bao'an District, Shenzhen, China

**T** +86 0755 2747 1942

**E** service@ginverter.com

**W** www.ginverter.com

GR-UM-210-A-00

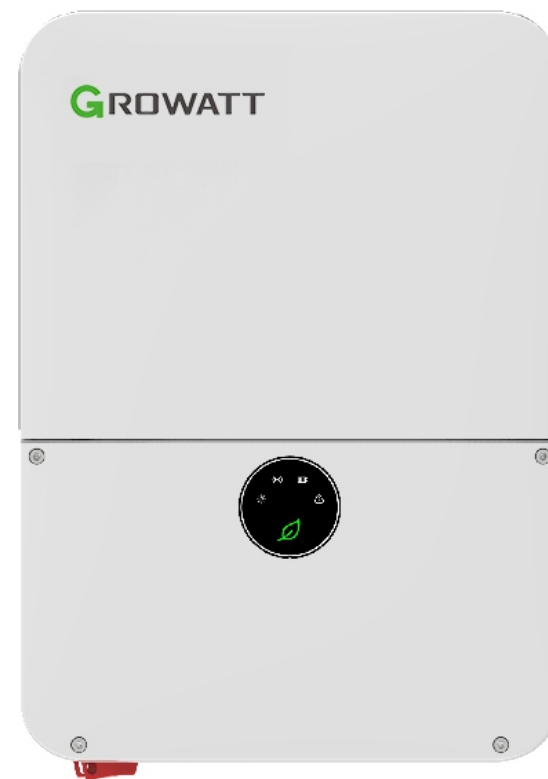

# Installation & Operation Manual

# List

## 1 Information on this document

- 1.1 Validity
- 1.2 Target Group
- 1.3 Storage of the manuals
- 1.4 Symbols in this document
- 1.5 Glossary

## 2 Safety

- 2.1 Intended Use
- 2.2 Qualification of skilled person
- 2.3 Safety instruction
- 2.4 Certified countries
- 2.5 DC and AC disconnect
- 2.6 Grounding the PV modules
- 2.7 Appropriated Usage
- 2.8 Operation Warnings

## 3 Product description

- 3.1 Inverter Overview
- 3.2 Information of Label
- 3.3 Inverter Dimension and Weight
- 3.4 Arc-Fault Circuit Interrupter
- 3.5 Transportation

## 4 Inspection of delivery

- 4.1 Unpacking and inspection

## 5 Instruction

- 5.1 Safety instruction
- 5.2 Selecting the installation location
- 5.3 Opening conduit drill guides
- 5.4 Mounting the inverter

## 6 Electrical connection

- 6.1 Safety
- 6.2 Intended use
- 6.3 Overview of the connection area
- 6.4 Grounding
- 6.5 AC connection
- 6.6 PV connection
- 6.7 Battery connection
- 6.8 Energy Meter connection
- 6.9 Communication connection

## 7 Commissioning

- 7.1 Checking Before Power-On
- 7.2 Powering on the system
- 7.3 LED description
- 7.4 Powering off the system
- 7.5 Button

## 8 Operations on the Shinephone APP

- 8.1 Overview
- 8.2 APP Download
- 8.3 APP Login page
- 8.4 Connecting to the inverter local Wi-Fi network
- 8.5 Quick setting
- 8.6 ESS Mode setting

## 9 Power Control System Introduction

## 10 Cleaning and Care

- 10.1 Checking the inverter
- 10.2 Checking the DC disconnect
- 10.3 Cleaning the Inverter
- 10.4 Trouble shooting

## 11 Decommissioning

- 11.1 Dismantling the Inverter
- 11.2 Packing the Inverter
- 11.3 Storing the Inverter
- 11.4 Disposing of the Inverter

## 12 Growatt Warranty

## 13 Technical Data

- 13.1 Specification
- 13.2 Efficiency curve

## 14 Contact Us

# 1 Information on this document

## 1.1 Validity

This manual describes the assembly, installation, commissioning and maintenance of the following Growatt Inverter model:

MIN 3000TL-XH-US	MIN 8200TL-XH-US
MIN 3800TL-XH-US	MIN 9000TL-XH-US
MIN 5000TL-XH-US	MIN 10000TL-XH-US
MIN 6000TL-XH-US	MIN 11400TL-XH-US
MIN 7600TL-XH-US	

This manual does not cover any details concerning equipment connected to the TL-XH-US (e.g. PV modules). Information concerning the connected equipment is available from the manufacturer of the equipment.

## 1.2 Target Group

This manual is for qualified personnel. Qualified personnel have received training and have demonstrated skills and knowledge in the construction and operation of this device. Qualified Personnel are trained to deal with the dangers and hazards involved in installing electric devices.



## 1.3 Storage of the manuals



Find further information on special topics in the download area at <http://www.growatt-america.com>. The manual and other documents must be stored in a convenient place and be available at all times. We assume no liability for any damage caused by failure to observe these instructions. For possible changes in this manual, GROWATT NEW ENERGY CO., LTD accepts no responsibilities to inform the users.

## 1.4 Symbols in this document





### 1.4.1 Warnings in this document

A warning describes a hazard to equipment or personnel. It calls attention to a procedure or practice, which, if not correctly performed or adhered to, could result in damage to or destruction of part or all of the Growatt equipment and/or other equipment connected to the Growatt equipment or personal injury.

 DANGER	DANGER indicates a hazardous situation which, if not avoided, will result in death or serious injury. DANGER indique une situation dangereuse qui, si elle n'est pas évitée, est susceptible de provoquer un décès ou des blessures graves.
 WARNING	WARNING indicates a hazardous situation which, if not avoided, could result in death or serious injury. AVERTISSEMENT indique une situation dangereuse qui, si elle n'est pas évitée, pourrait entraîner la mort ou des blessures graves.
 CAUTION	CAUTION indicates a hazardous situation which, if not avoided, could result in minor or moderate injury. ATTENTION indique une situation dangereuse qui, si elle n'est pas évitée, pourrait entraîner des blessures mineures ou modérées.

 NOTICE	NOTICE is used to address practices not related to personal injury. AVIS est utilisé pour traiter des pratiques non liées aux blessures corporelles.
	Information that you must read and know to ensure optimal operation of the system. Informations que vous devez lire et connaître pour assurer un fonctionnement optimal du système.

### 1.4.2 Markings on this product

Symbol	Explanation
	Risk of electrical shock Risque d'électrocution
	Risk of burns injuries Risque de brûlures
	Wait for 5 minutes before engaging in the indicated action Attendez 5 minutes avant de vous engager dans l'action indiquée
	Earth Ground Terre au sol
	Observe the operating instructions Respectez les instructions de service

## 1.5 Glossary

AC

Abbreviation for "Alternating Current".

DC

Abbreviation for "Direct Current".

Energy

Energy is measured in Wh (watt hours), kWh (kilowatt hours) or MWh (megawatt hours). The energy is the power calculated over time. If, for example, your inverter operates at a constant power of 4600 W for half an hour and then at a constant power of 2300 W for another half an hour, it has fed 3450Wh of energy into the power distribution grid within that hour.

Power

Power is measured in W (watts), kW (kilowatts) or MW (megawatts). Power is an instantaneous value. It displays the power your inverter is currently feeding into the power distribution grid.

## Power rate

Power rate is the ratio of current power feeding into the power distribution grid and the maximum power of the inverter that can feed into the power distribution grid.

## Power Factor

Power factor is the ratio of true power or watts to apparent power or volt amps. They are identical only when current and voltage are in phase then the power factor is 1.0. The power in an ac circuit is very seldom equal to the direct product of the volts and amperes. In order to find the power of a single phase ac circuit the product of volts and amperes must be multiplied by the power factor.

## PV

Abbreviation for photovoltaic.

## wireless communication

The external wireless communication technology is a radio technology that allows the inverter and other communication products to communicate with each other. The external wireless communication does not require line of sight between the devices and it is selective purchasing.

## 2.1 Intended Use





The Growatt MIN TL-XH US series inverter converts the DC current generated by the photovoltaic (PV) modules to grid-compliant alternating current and performs single-phase feed-in into the electricity grid. This series inverter is built according to all required safety rules. Nevertheless, improper use may cause lethal hazards for the operator or third parties, or may result in damage to the units and other property.



## 2.2 Qualification of skilled person

This grid-tied inverter system operates only when properly connected to the AC distribution network. Before connecting the TL-XH US to the power distribution grid, contact the local power distribution grid company. This connection must be made only by qualified technical personnel to connect, and only after receiving appropriate approvals, as required by the local authority having jurisdiction.

## 2.3 Safety instruction

The GROWATT TL-XH-US Inverters is designed and tested according to international safety requirements (UL1741); however, certain safety precautions must be observed when installing and operating this inverter. Read and follow all instructions, cautions and warnings in this installation manual. If questions arise, please contact Growatt's technical services at +1 (818)800-9455.

	<p><b>Danger to life due to lethal voltages!</b> Lethal voltages are present within the unit and on the power supply lines. Therefore, only authorized electricians may install and open the unit. Even unit. Even when the unit is disconnected, high contact voltages may still be present within the unit</p>
	<p><b>Danger of burn injuries due to hot enclosure parts!</b> During operation, the four sides of the enclosure lid and the heat sink/heat sink may become hot. Only hot. Only touch the front enclosure lid during operation.</p>
	<p><b>Electric arc hazards</b> The product has large electrical potential differences between its conductors/sits conductors. Arc flashes can occur through air when high-voltage current flows. Do not work on the product during operation.</p>
	<p><b>Risk of fire</b> Improper installation of the product may cause a fire.</p>
	<p><b>Possible damage to health as a result of the effects of radiation!</b> In special cases, there may still be interference for the specified application/specified application area despite maintaining standardized emission limit values/limit values (e.g. when sensitive equipment is located at the setup location or when the setup location is near radio or television receivers). In this case, the operator is obliged to take proper action to rectify the situation. Do not stay closer than 8 inch to the inverter for any length of time.</p>

 NOTICE	Grounding the PV generator Comply with the local requirements for grounding the PV modules and modules and the PV generator. Growatt recommends connecting the generator to the generator frame and other electrically conductive surfaces in a manner which ensures continuous conduction with ground these in order to have optimal protection of the system and personnel.
 NOTICE	Permanent connection The inverter may only be operated with a permanent connection to the public power grid. The inverter is not intended for mobile use. Any other or additional use is not considered the intended use. The manufacturer/supplier is not liable for damage caused by such unintended use. Damage caused by such unintended use is at the sole risk of the operator.
 NOTICE	PV modules Capacitive Discharge Currents PV modules with large capacities relative to earth, such as thin-film PV modules with cells on a metallic substrate, may only be used if their coupling capacity does not exceed 1uF. During feed-in operation, a leakage current flows from the cells to earth, the size of which depends on the manner in which the PV modules are installed (e.g. foil on metal roof) and on the weather (rain, snow). This "normal" leakage current may not exceed 50mA due to the fact that the inverter would otherwise automatically disconnect from the electricity grid as a protective measure.

## 2.4 Certified countries

With the appropriate settings, the unit will comply with the requirements specified in the following standards and directives

- UL1741, UL1741SA
- IEEE1547.2018, CA Rule21, Rule 14 (HECO Compliant)
- CSA C22.2
- FCC Part15
- UL1699B

Growatt can preset special grid parameters for other countries installation locations according to customer requests after evaluation by Growatt. You can make later modifications yourself by changing software parameters with respective communication products. To change the grid-relevant parameters, an access code is required; please contact Growatt support if needed.

## 2.5 DC and AC disconnect

Isolate the MIN TL-XH US Inverter securely from the grid, the PV generators and the HV battery using AC and DC Switch. DC and AC Switch shall be able to disconnect all ungrounded conductors after installation.

## 2.6 Grounding the PV modules

The MIN TL-XH US series product is a transformer-less inverter and has no galvanic separation. Therefore, the inverter may only be operated with ungrounded PV array. Do not ground the DC circuits of the PV modules connected to the MIN TL-XH US inverter as it must comply with National Electric Code, Article 690.35 'Ungrounded Photovoltaic Power Systems' and local regulations for ungrounded systems. Only ground the mounting frame of the PV modules. If you connect a grounded PV array to the MIN TL-XH US Inverter, the fault LED will flash, and there is an error message 'PV ISO LOW' appeared on Shine sever or Shine phone.

## 2.7 Appropriated Usage

The Growatt Inverter converts DC Current from PV generator into AC current. The inverter is suitable for mounting indoors and outdoors. You can use the AC current generated as follows:



House grid	Energy flows into the house grid. The consumers connected, for example, household devices or lighting, consume the energy. The energy left over is fed into the public grid. When the Growatt is not generating any energy, e.g., at night, the consumers which are connected are supplied by the public grid. The Growatt does not have its own energy meter. When energy is fed into the public grid, the energy meter spins backwards.
Public grid	Energy is fed directly into the public grid. The Growatt is connected to a separate energy meter. The energy produced is compensated at a rate depending on the electric power company.

### 2.7.1 Assembly Warnings

 WARNING	<ul style="list-style-type: none"> <li>➤ Prior to installation, inspect the unit to ensure absence of any transport or handling damage, which could affect insulation integrity or safety clearances; failure to do so could result in safety hazards.</li> <li>➤ Assemble the inverter per the instructions in this manual. Use care when choosing installation location and adhere to specified cooling requirements.</li> <li>➤ Unauthorized removal of necessary protections, improper use, incorrect installation and operation may lead to serious safety and shock hazards and/or equipment damage.</li> <li>➤ In order to minimize the potential of a shock hazard due to hazardous voltages, cover the entire solar array with dark material prior to connecting the array to any equipment.</li> </ul>
--	--

# Product Description 3

## 2.7.2 Electrical Connection Warnings

 <b>DANGER</b>	<ul style="list-style-type: none"> <li>➤ The components in the inverter are live. Touching live components can result in serious injury or death.</li> <li>• Do not open the inverter except the wire box by qualified persons.</li> <li>• Electrical installation, repairs and conversions may only be carried out by electrically qualified persons.</li> <li>• Do not touch damaged inverters.</li> <li>➤ Danger to life due to high voltages in the inverter.</li> <li>• There is residual voltage in the inverter. The inverter takes 20 minutes to discharge.</li> <li>• Wait 20 minutes before you open the wire box.</li> <li>➤ Persons with limited physical or mental abilities may only work with the Growatt inverter following proper instruction and under constant supervision. Children are forbidden to play with the Growatt inverter. Must keep the Growatt inverter away from children.</li> </ul>
 <b>WARNING</b>	<ul style="list-style-type: none"> <li>➤ Make all electrical connections (e.g. conductor termination, fuses, PE connection, etc.) in accordance with prevailing regulations. When working with the inverter powered on, adhere to all prevailing safety regulations to minimize risk of accidents.</li> <li>➤ Systems with inverters typically require additional control (e.g., switches, disconnects) or protective devices (e.g., fusing circuit breakers) depending upon the prevailing safety rules.</li> </ul>

## 2.8 Operation Warnings

 <b>WARNING</b>	<ul style="list-style-type: none"> <li>➤ Anytime the inverter has been disconnected from the power network, use extreme caution as some components can retain charge sufficient to create a shock hazard; to minimize occurrence of such conditions, comply with all corresponding safety symbols and markings present on the unit and in this manual.</li> <li>➤ Ensure all covers and doors are closed and secure during operation. All operations regarding transport, installation and start-up, including maintenance must be operated by qualified, trained personnel and in compliance with all prevailing codes and regulations.</li> <li>➤ Although designed to meet all safety requirements, some parts and surfaces of Inverter are still hot during operation. To reduce the risk of injury, do not touch the heat sink at the back of the PV-Inverter or nearby surfaces while Inverter is operating.</li> <li>➤ Incorrect sizing of the PV plant may result in voltages being present which could destroy the inverter. The Shinephone will read the error message 'PV-Over voltage'. Turn the rotary switch of the DC Disconnect to the Off position immediately. Contact installer.</li> </ul>
---	--

## 3.1 Inverter Overview

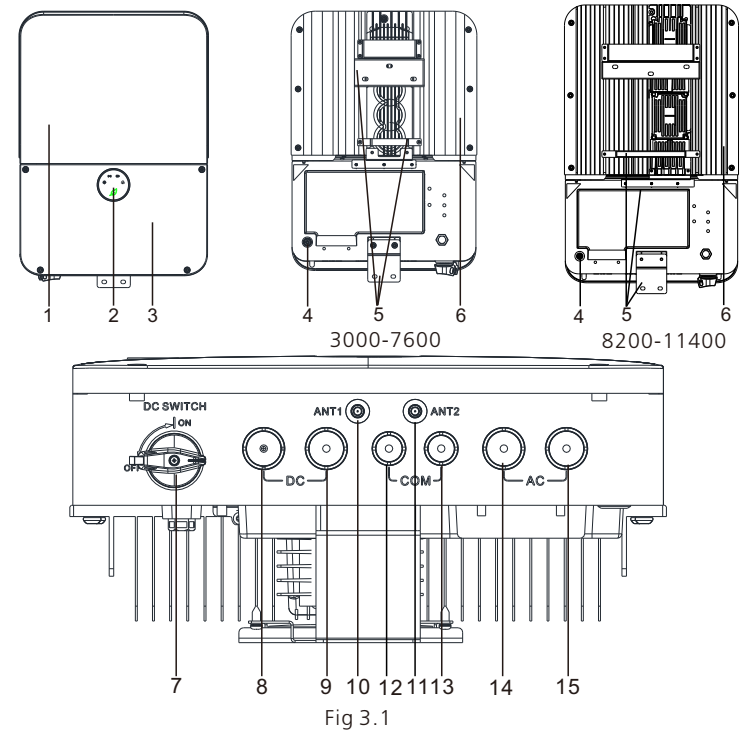

- |                            |                         |                        |
|----------------------------|-------------------------|------------------------|
| (1) Host panel             | (2) LED indicators      | (3) Wiring box cover   |
| (4) Battery wake-up button | (5) Mounting bracket    | (6) Heat sink          |
| (7) DC switch              | (8) PV input port       | (9) Battery input port |
| (10) Antenna port 1        | (11) Antenna port 2     | (12) Comm. port 1      |
| (13) Comm. port 2          | (14) Backup output port | (15) AC output port    |

## 3.2 Information of Label

The labels provide technical information of the inverter. You can identify the inverter by the label, it is located on the enclosure of the inverter. Different type labels can be found on the MIN TL-XH US models.

- The type of product (Type/Model)
- Device-specific characteristics
- Specifications of the inverter
- Requirements of cable & torque
- AFCI certificates
- Serial number
- Warning

### 3.2.1 Product's label



<b>Growatt</b> Grid Support Hybrid Inverter	
Model name:	<b>MIN 11400TL-XH-US</b>
Range of PV input voltage:	<b>50~600 Vdc</b>
Max. PV input voltage:	<b>600 Vdc</b>
Max. PV input current of the MPP tracker:	<b>13.5 Adc</b>
Max. PV input short circuit current:	<b>16.9 Adc</b>
DC operating voltage range:	<b>360~550 V</b>
Max. DC input/output current:	<b>15 A/15 A</b>
Max. AC output power:	<b>11400 W</b>
Default grid voltage setting:	<b>240 Vac Split Phase</b>
Nominal grid voltage:	<b>240 Vac &amp; 208 Vac</b>
Range of grid voltage:	<b>211~264 Vac @ 240 Vac</b> <b>183~228 Vac @ 208 Vac</b>
Nominal grid frequency: <b>60 Hz</b>	
Range of grid frequency:	<b>59.5~60.5 Hz</b>
Max. output current: <b>48 Aac</b>	
Max. output overcurrent protection: <b>63 Aac</b>	
Output power factor:	<b>0.99 (0.8i~0.8c adj)</b>
Nominal backup power:	<b>5000 W @ 240 Vac</b>
Default backup voltage: <b>240 Vac</b>	
Enclosure: <b>Type 4X</b>	
Operation ambient temperature:	<b>-13°F~+140°F (de-rating above 113°F)</b>
Inverter type: <b>Grid support utility interactive transformer-less hybrid inverter</b>	
<b>Conform to UL STD. UL1741,UL1741SA IEEE1547,UL1699B</b>	
<b>Certified to CSA STD C22.2 NO.107.1</b>	
  	
<b>Intertek</b> 4003184	<b>Type 1</b> <b>Made in China</b>

Fig 3.2

### 3.2.2 Warning label

**CAUTION !**

- Risk of Electric Shock. Do Not Remove Cover. No User Serviceable Parts Inside. Refer Servicing To Qualified Service Personnel.
- Both ac and dc voltage sources are terminated inside this equipment. Each circuit must be individually disconnected before servicing.
- When the photovoltaic array is exposed to light, it supplies a dc voltage to this equipment.
- Risk of electric shock from energy stored in capacitor. Do not remove cover until 5 minutes after disconnecting all sources of supply.
- Risk of Electric Shock. Normally Grounded Conductors May Be Ungrounded and Energized When a Ground-Fault is Indicated

**CAUTION !**

Hot surfaces - To reduce the risk of burns - Do not touch.

**CAUTION !**

To reduce the risk of electric shock and fire-Do not connect to a circuit operating at more than 150 volts to ground.

**CAUTION !**

This unit has not been evaluated for some of the IEEE 1547-2018 and IEEE 1547.1-2020 Interoperability tests. This unit is provided with gateway in accordance with local code and local utility requirements.

**CAUTION !**

The maximum operating current of this system may be controlled electronically. Refer to manufacturer's instructions for more information.

**ATTENTION:**

- Risque de choc électrique. ne pas retirer la protection. Pas de parties utilisables à l'intérieur. Veuillez vous référer à un employé de service qualifié.
- Les sources de voltage CA et CC se trouvent à l'intérieur de l'équipement. Chaque circuit doit être déconnecté séparément avant manipulation.
- Lorsque le panneau photovoltaïque est exposé à la lumière, il fournit à l'équipement du courant continu.
- Risque de choc électrique provenant de l'énergie stockée dans le condensateur. Ne pas retirer la protection jusqu'à 5 minutes après avoir déconnecté toutes les sources d'énergie.
- Risque de choc électrique. Les conducteurs normalement à terre doivent être enterrés et alimentés lorsqu'une fuite à terre est signalée.

**ATTENTION:**

surfaces chaudes - afin de réduire les risques de brûlures - ne pas toucher.

**ATTENTION:**

Afin de réduire le risque de choc électrique et d'incendie - Ne pas se connecter à un circuit fonctionnant à plus de 150 volts à terre.

**ATTENTION:**

Cette unité n'a pas été évaluée pour certains des tests d'interopérabilité IEEE 1547-2018 et IEEE 1547.1-2020. Cet appareil est fourni avec une passerelle conformément au code local et aux exigences des services publics locaux.

**ATTENTION:**

Le courant de fonctionnement maximal de ce système peut être contrôlé électroniquement. Faire référence à instructions du fabricant pour plus d'informations



Fig 3.3



### 3.2.3 Labels in the wire box

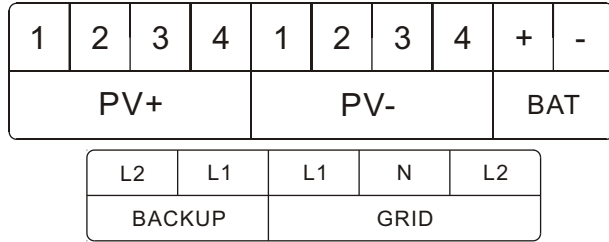

Fig 3.4

### 3.3 Inverter Dimension and Weight

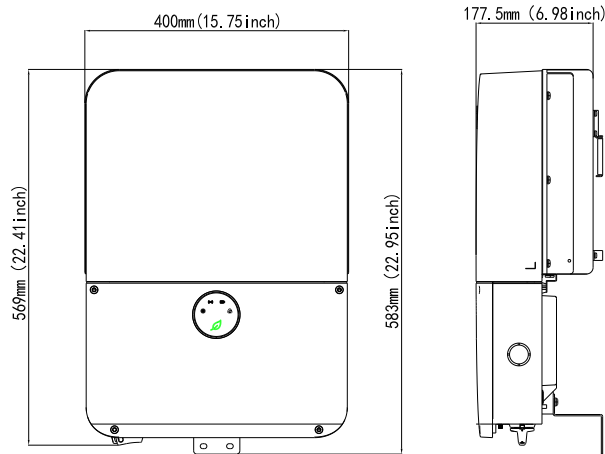
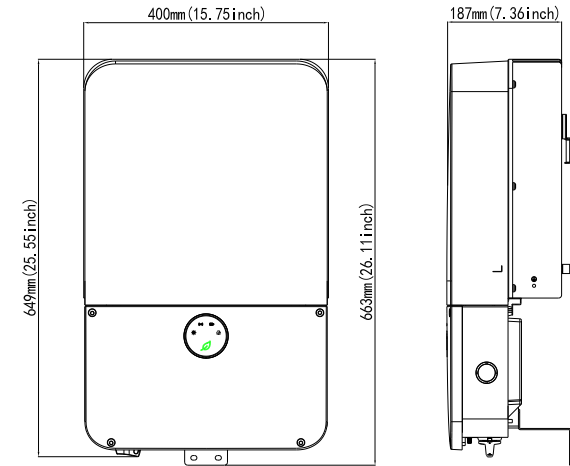

Fig 3.5

Model	MIN 3000~7600TL-XH-US
Dimension	400*569*177.5 mm(15.75*22.41*6.98 inch)
Weight	14.65kg(32.30lbs)



Model	MIN 8200~11400TL-XH-US
Dimension	400*649*187 mm(15.75*25.55*7.36 inch)
Weight	20.5kg(45.19lbs)

### 3.4 Arc-Fault Circuit Interrupter

In accordance with the National Electrical Code Article 690.11, the inverter has a system for the recognition of electric arc detection and interruption. An electric arc with a power of 300 W or greater must be interrupted by the AFCI within the time specified by UL 1699B. A tripped AFCI can only be reset manually. You can deactivate the automatic arc fault detection and interruption (AFCI) via a communication product in "Installer" mode if you do not require the function. The 2011 edition of the National Electrical Code R, Section 690.11 stipulates that newly installed PV systems attached to a building must be fitted with a means of detecting and disconnecting serial electric arcs (AFCI) on the PV side.

### 3.5. Transportation

The inverter is thoroughly tested and strictly inspected before delivery. Our inverters leave our factory in proper electrical and mechanical condition. Special packaging ensures safe and careful transportation. However, transport damage may still occur. The shipping company is responsible in such cases. Thoroughly inspect the inverter upon delivery. Immediately notify the responsible shipping company if you discover any damage to the packaging which indicates that the inverter may have been damaged or if you discover any visible damage to the inverter. We will be glad to assist you, if required. When transporting the inverter, the original or equivalent packaging should be used, and the maximum layers for original carton is six, as this ensures safe transport.

# 4 Inspection of delivery

## 4.1 Unpacking and inspection

The inverter is thoroughly tested and inspected strictly before delivery. Our inverters leave our factory in proper electrical and mechanical condition. Special packaging ensures safety and careful transportation. However, transportation damage may still occur. The shipping company is responsible in such cases. Thoroughly inspect the inverter upon delivery. Immediately notify the responsible shipping company if you discover any damage to the packaging which indicates that the inverter may have been damaged or if you discover any visible damage to the inverter. We will be glad to assist you, if required. When transporting the inverter, the original or equivalent packaging should be used, and the maximum layers for original carton is four, as this ensures safe transport.

After opening the package, please check the contents of the box. It should contain the following. Please check all of the accessories carefully in the carton. If anything missing, contact your dealer at once.

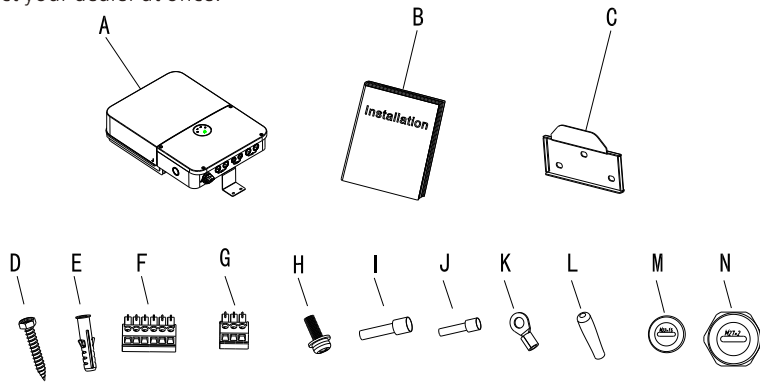

Fig 4.1

Object	Description	Quantity
A	MIN XH-US inverter	1
B	Manual	1
C	Mounting bracket	1
D	Self-tapping screw	3
E	Plastic expansion pipe	3
F	Connector for RS485	1
G	Connector for Meter RS485	1
H	Safety-lock screw	2
I	Cord end terminal for AC side wiring	5
J	Cord end terminal for DC side wiring	16
K	R type terminal for grounding	1
L	Antenna	1
M	22# Blank cap	2
N	28# Blank cap	4

# Instruction 5

## 5.1 Safety instruction

<p>DANGER</p>	<p>Danger to life from electric shock due to high voltages High voltages are present in the DC cables and later during operation in the conductive components of the inverter. These can cause fatal electric shocks.</p>
<p>DANGER</p>	<p>Danger to life due to fire or explosion Despite careful construction, electrical devices can cause fires. Do not install the inverter on easily flammable materials and where flammable materials are stored.</p>
<p>WARNING</p>	<p>Risk of burns due to hot enclosure parts The surface of the inverter can become very hot. Touching the surface can result in burns. Do not touch hot surfaces. During operation, do not touch any parts other than the lower enclosure lid of the inverter. Mount the inverter in such a way that it cannot be touched inadvertently.</p>

## 5.2 Selecting the installation location

This is the guidance for installer to choose a suitable installation location, and to avoid potential damages to device and operators. Rain-tight or wet location hubs that comply with the requirements in the Standard for Conduit, Tubing, and Cable Fittings, UL 514B, are to be used.

- The unit shall be mounted at least 36inch (3 feet) above the ground. The installation location must be suitable for the inverter's weight and dimensions for a long period time.
  - Select a wall or solid vertical surface that can support the PV-Inverter.
  - Select the installation location so that the status display can be easily viewed.
  - Select a well-ventilated location sheltered from direct sunlight and rain.
  - Do not install the inverter on structures constructed of flammable or thermo labile materials.
  - **The humidity of the installation location should be 0~100% without condensation.**
  - The installation location must be freely and safely to access at all times.
- When possible, mount the inverter vertically or tilted backwards by max. 15°. And make sure the connection of inverter must be downwards. Never install horizontal and avoids forward and sideways tilt.

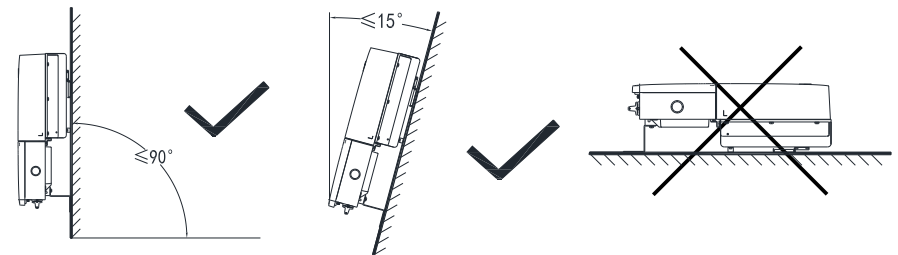

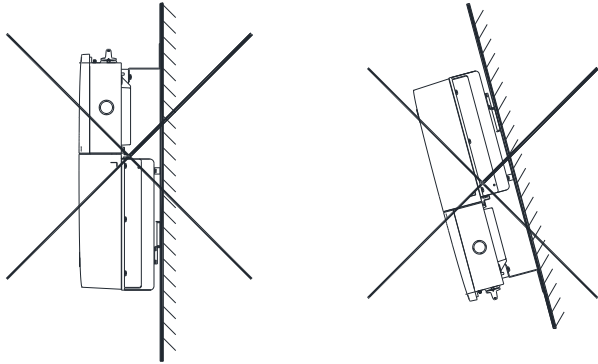

Fig 5.1

- Ensure that the inverter is out of the children's reach.
- Don't put any physical item things on the inverter. Do not cover the inverter.
- The location shall be away from strong electromagnetic interference.
- Do not install the inverter near television antenna or any other antennas and antenna cables.
- Providing better ventilation for the inverter to ensure the heat escape adequately. The ambient temperature should be below 40°C(104°F) to ensure optimum operation.
- Do not expose the inverter to direct sunlight, as this can cause excessive heating and thus power reduction.
- Observe the Min. clearances to walls, other inverters, or objects as shown below:

Ambient dimensions of one inverter

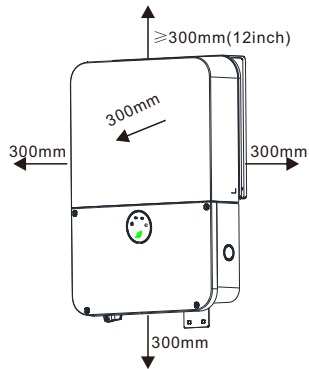

Fig 5.2

Ambient dimensions of series inverters

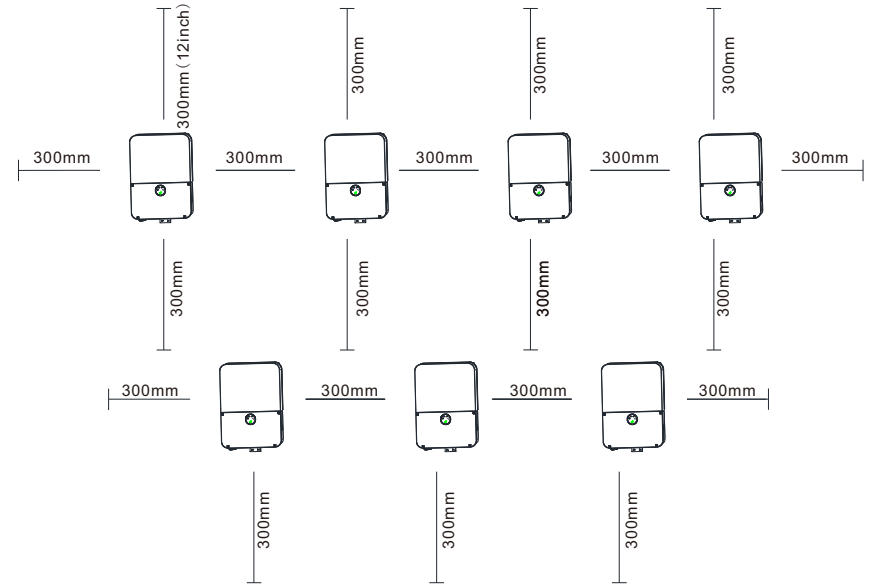

Fig 5.3

- There must be sufficient clearance between the individual inverters to ensure that the cooling air of the adjacent inverter is not taken in.
- If necessary, increase the clearance spaces and make sure there is enough fresh air supply to ensure sufficient cooling of the inverters.
- The inverter can't install to solarization,drench,firm location.We suggest that the inverters should be installed at the location with some cover or protection.



Fig 5.4

➤ Please make sure the inverter is installed at the Proper location. The inverter can't install close to trunk.

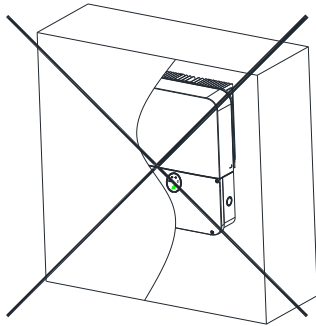



Fig 5.5

### 5.3 Opening conduit drill guides

 <b>INFORMATION</b>	<ul style="list-style-type: none"> <li>➤ This step may be performed before or after mounting the inverter</li> <li>➤ General tools Cordless drill or screwdriver and bits suitable for the surface on which the inverter will be installed and for opening the Safety Switch drill guides.</li> </ul>
 <b>WARNING</b>	<p>Ensure no live voltages are present on PV input and AC output circuits, and verify that the DC disconnect, AC disconnect, and dedicated AC branch circuit breaker are in the "OFF" position, before inverter installation.</p> <p>If no PV string is connected to a DC input terminal of the inverter, do not open the conduit drill guide.</p>

- 1.Ensure the inverter ON/OFF switch is OFF.
- 2.Looseen the screws on the front cover of the wiring box, as shown below:

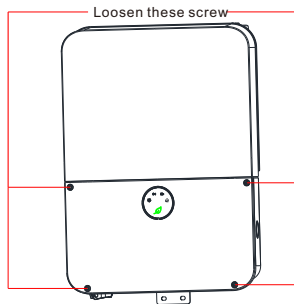

Fig 5.6

- 1.RemoveRemove the cover.
- 2.Open the required AC ,AC, DC and COM conduit drill guides according to the conduits used in the installation: The drill guides are located at the bottom and sides of the enclosure, each with two sizes:3/4" and 1".
- 3.Open the required drill guides, the number of the opened guides hole according to actual requirement, taking care not to interface with any of the internal components. It is recommended to use a Unibit drill.

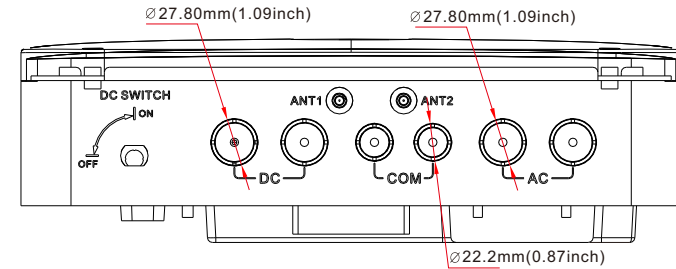



Fig 5.7

### 5.4 Mounting the inverter

#### 5.4.1 Preparatory work

 <b>INFORMATION</b>	<ul style="list-style-type: none"> <li>➤ General tools Personal safety equipment such as gloves, helmet, goggles, ear plugs, safety harness etc. Step ladders. Knife.</li> <li>➤ Tools for mechanical installation Equipment for transporting and lifting the inverter Electric(hammer) drill Hammer Set of drill bits, wrenches, sockets and screw bits Socket driver, screw driver Tape measure Level Pencil or other marker Fastening screws, plugs, etc.</li> </ul>
--	---

#### 5.4.2 Fixed the Inverter on wall

 <b>DANGER</b>	<p>In order to avoid electrical shock or other injury, inspect existing electronic or plumbing installations before drilling holes.</p>
--	---

# Electrical connection 6

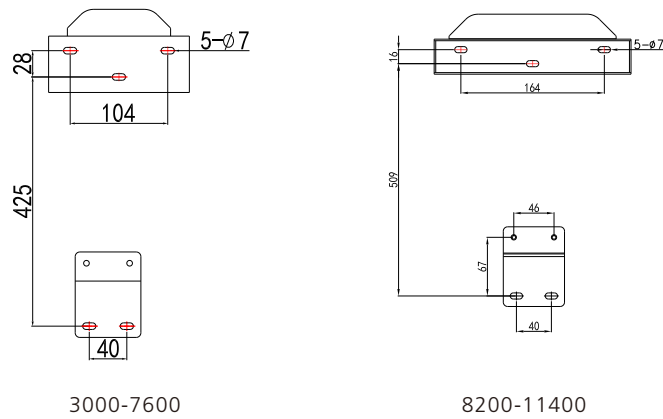

Fig 5.8

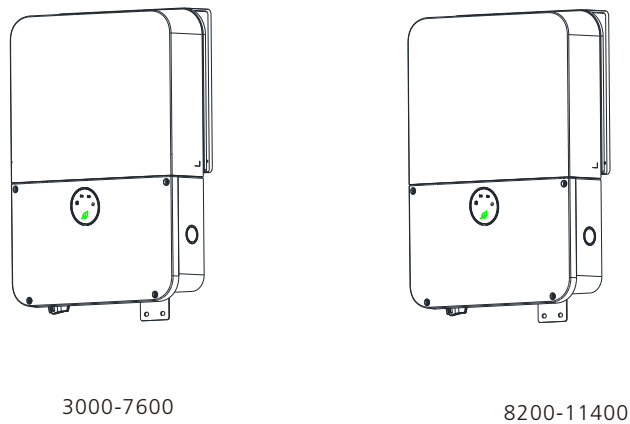







Fig 5.9

## 6.1 Safety

 <b>DANGER</b>	<p>Danger to life from electric shock due to high voltages High voltages are present in the DC cables and later during operation in the conductive components of the inverter. These can cause fatal electric shocks. Before connecting, make sure the AC &amp; DC disconnect is turned off and measure the voltage within the limits of system.</p> <p>Electric shock hazard, the DC conductors of this photovoltaic system are normally ungrounded but will become intermittently grounded without indication when the inverter measures the PV array isolation. Because isolation. Because of the transformer less design, the DC positive pole and DC negative pole of PV arrays are not permitted to be grounded.</p> <p>Do not disconnect the DC connectors under load!</p>
 <b>WARNING</b>	<p>Risk of burns due to hot surfaces The surface of the inverter can become very hot. Touching the surface can result in burns.</p> <p>Do not touch hot surfaces. During operation, do not touch any parts other than the lower enclosure lid of the inverter. Mount the inverter in such a way that it cannot be touched inadvertently.</p>
 <b>DANGER</b>	<ol style="list-style-type: none"> <li>1. All electrical installations shall be done in accordance with the local and national electrical codes. Do not remove the casing. Inverter contains no user serviceable parts. Refer servicing to qualified service personnel. All wiring and electrical installation should be conducted by a qualified service personnel.</li> <li>2. Carefully remove the unit from its packaging and inspect for external damage. If you find any imperfections, please contact your local dealer.</li> <li>3. Be sure that the inverters connect to the ground in order to protect property and personal safety.</li> <li>4. The inverter must only be operated with PV generator. Do not connect any other source of energy to it.</li> <li>5. Both AC and DC voltage sources are terminated inside the PV Inverter. Please disconnect these circuits before servicing.</li> <li>6. This unit is designed to feed power to the public power grid (utility) only. Do not connect this unit to an AC source or generator. Connecting Inverter to external devices could result in serious damage to your equipment.</li> <li>7. When a photovoltaic panel is exposed to light, it generates a DC voltage. When connected to this equipment, a photovoltaic panel will charge the DC link capacitors.</li> <li>8. Energy stored in this equipment's DC link capacitors presents a risk of electric shock. Even after the unit is disconnected from the grid and photovoltaic panels, high voltages may still exist inside the PV-Inverter. Do not remove the casing until at least 5 minutes after disconnecting all power sources.</li> <li>9. Although designed to meet all safety requirements, some parts and surfaces of Inverter are still hot during operation. To reduce the risk of injury, do not touch the heat sink at the back of the PV-Inverter or nearby surfaces while Inverter is operating.</li> <li>10. Before any electrical wiring can be connected to the inverter, the inverter must be permanently mounted.</li> </ol>

 DANGER	Danger of damage to electronic components due to electrostatic discharge. Take appropriate ESD precautions when replacing and installing the inverter.
 DANGER	Before connecting the power cables, you must connect both ground wire of DC and AC side in wire box first.

- Connecting the second protective conductor
- If the installation requires, the earth terminal can be used to connect a second protective conductor or as equipment bonding. This prevents touch current if the original protective conductor fails.

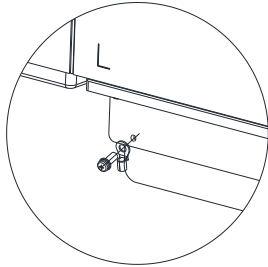



Fig 6.1

Electrical installations

 INFORMATION	All electrical installations must be done in accordance with all local electrical codes and the NATIONAL Electrical Code®, ANSI/NFPA 70. For installation in Canada the installations must be done in accordance with applicable Canadian standards. Before connecting the inverter to the power distribution grid, contact your local electric utility company. This connection may be made only by electrically qualified persons.
 INFORMATION	Tools for electrical installation <ul style="list-style-type: none"> <li>•Hexagonal driver 3mm for securing the front cover and AC connector.</li> <li>•Flat screwdriver 3mm for releasing spring terminals.</li> <li>•Cable and wire strippers.</li> <li>•Side cutters.</li> <li>•Crimping tool and cable lugs.</li> <li>•Cable marking equipment.</li> <li>•Digital multi-meter (insulation tester) with DC and AC sensitive current clamp, voltage measurement (max. 1000 VDC) and continuity testing functions.</li> </ul>

## 6.2 Intended use

The unit converts the DC (Direct Current) generated by the photovoltaic (PV) modules to grid-compliant AC (Alternating Current) and feed-in into the electricity grid. Growatt inverters are built according to all required safety rules. Nevertheless, improper use may cause lethal hazards for the operator or third parties, or may result in damage to the units and other property.

This unit or system is provided with fixed trip limits and shall not be aggregated above 30 kW on a single Point of Common Connection.

- PV Panel: Provide DC power to inverter. If using MIN TL-XH-US series PV inverter With Arc fault current detection function, we recommend consumer connect the Tracker A and Tracker B to different PV module strings.
- Converts DC (Direct Current) power from PV panel to AC (Alternating Current) power. Because Inverter is grid-connected, it controls the current amplitude according to the PV module power supply. Inverter always tries to convert the maximum power from your PV module.
- Connection system: This 'interface' between Utility and PV inverter may consist of electrical breaker, fuse and connecting terminals. To comply with local safety standards and codes, the connection system should be designed and implemented by a qualified technician.
- Utility: Referred to as 'grid' in this manual, is the way your electric power company provides power to your place.

### 6.2.1 AC circuit breaker requirements

 WARNING	You must install a separate single-phase circuit-breaker or other load disconnection unit for each inverter in order to ensure that the inverter can be safely disconnected under load. NOTE: The inverter has the function of detecting residual current and protecting the inverter against residual current. If your inverter has to equip an AC breaker which has the function of detecting residual current, you must choose a AC breaker with the rating residual current more than 300mA.
--	---

We suggest you to choose the AC breaker rating by below table:

MIN 3000 TL-XH-US	15A/240V
MIN 3800 TL-XH-US	20A/240V
MIN 5000 TL-XH-US	25A/240V
MIN 6000 TL-XH-US	30A/240V
MIN 7600 TL-XH-US	40A/240V
MIN 8200 TL-XH-US	63A/240V
MIN 9000 TL-XH-US	63A/240V
MIN 10000 TL-XH-US	63A/240V
MIN 114000 TL-XH-US	63A/240V

### 6.2.2 Supported Grid Type

The MIN TL-XH-US series inverters are grid-tied to the public utility, the inverters is software configurable via the user display panel for various 208Vac or 240Vac 60Hz public utility. The following figures illustrate grids that are supported by the series inverters. Ground connection is required for all grids. Check the grid (AC utility) configuration type, you can use the tool to select the grid model to make the inverter suited for the local grid type in the inverter first time starting.

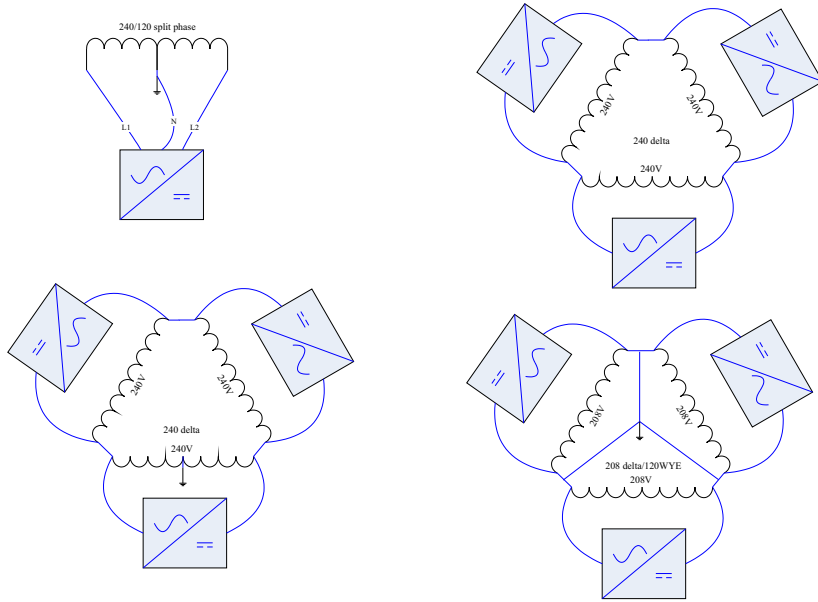

Fig 6.2

### 6.2.3 PV string consideration

There are a large number of PV module string combinations that will offer optimal performance from either the MIN TL-XH US series inverters.

 <b>WARNING</b>	Follow the temperature multiplication factors given in NEC 690.7 table and the PV module manufacturer specified V/Temp coefficient to ensure PV string voltage is less than 600 Vdc. Maximum inverter PV input voltage for all possible weather conditions in the location of installation.
--------------------	---

### 6.2.4 Cable requirements

 <b>NOTICE</b>	Use only solid or stranded wire but not fine stranded wire. Use cables with high ambient temperatures. Use cables with a large cross-section.
-------------------	---

8AWG for PV, is the The maximum allowed wire size for PV cable is 8AWG.  
 8AWG for Battery, is the The maximum allowed wire size for battery cable is 8AWG.  
 4AWG for AC, is the The maximum allowed wire size for AC able is 4AWG.

### 6.3 Overview of the connection area

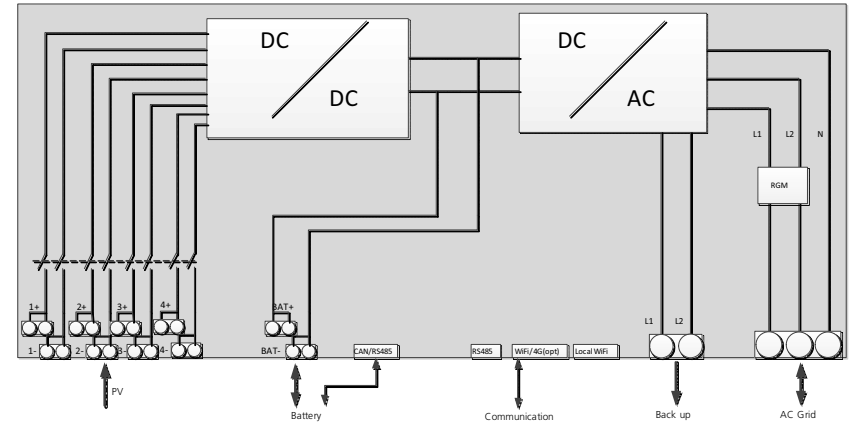

Fig 6.3

### 6.3.1 AC connection area

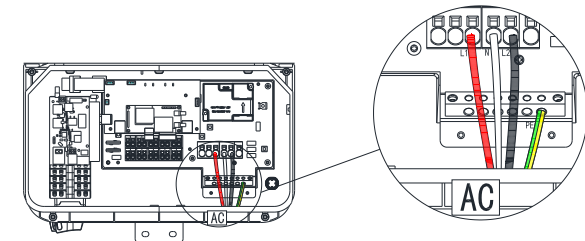

Fig 6.4

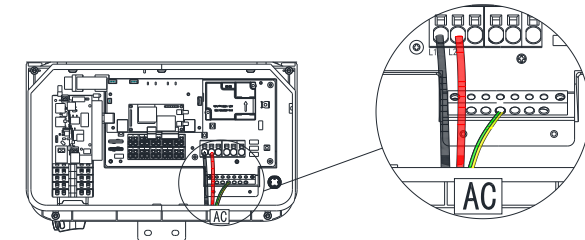

Fig 6.5

### 6.3.2 DC connection area

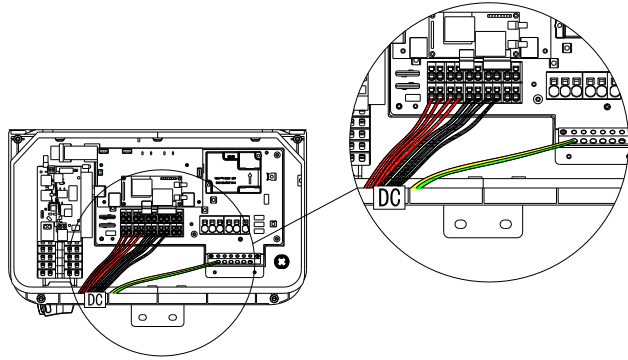

Fig 6.6

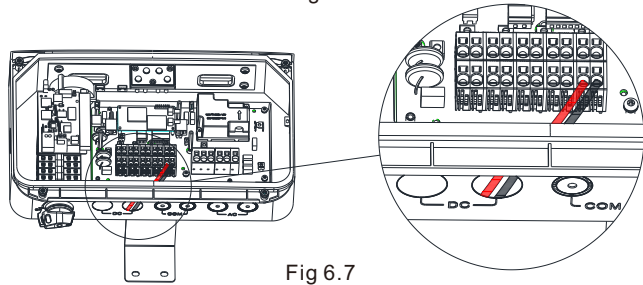

Fig 6.7

### 6.3.3 Communication connection area

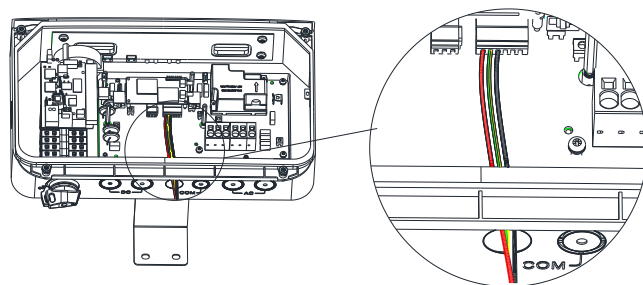

Fig 6.8

### 6.3.4 RGM connection area

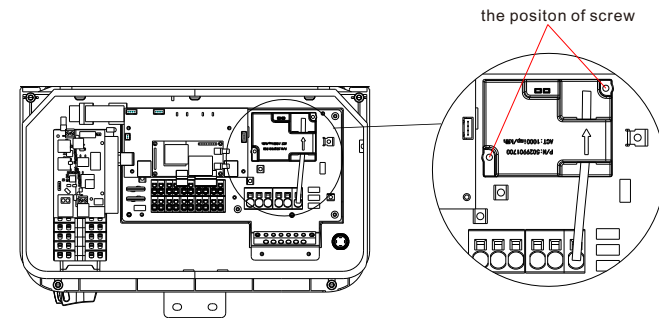

Fig 6.9

## 6.4 Grounding

### AC Grounding

It must be connected to the AC grounding conductor of the power distribution grid via the ground terminal (PE). The AC input and AC output circuits are isolated from the enclosure and system grounding, if required by Section 250 of the National Electrical Code, ANSI/NFPA 70.

### Grounding Electrode Terminal (GET)

A grounding electrode terminal may be required to local regulations.

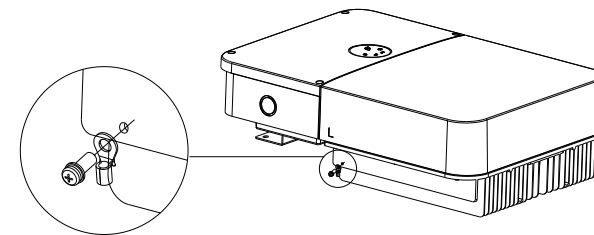

Fig 6.10 outside GET

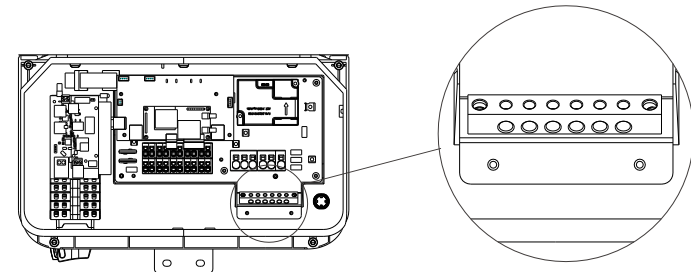

Fig 6.11 inside GET



## 6.5 AC connection

### 6.5.1 Connecting the AC output power cable for AC Grid

- Strip 0.7 inches (18mm) of the AC cable insulation.
- Insert the AC conduit into the AC-side drill guide that was opened
- Insert the 0.8\*4.0 mm standard flat-blade screwdriver and press the release mechanism and open the clamp
- Connect the cable to the appropriate terminal blocks according to the labels on the terminal blocks(L1,N,L2,of AC Grid)
- Insert the cable into the round opening and remove the screwdriver, then the cable is automatically clamped
- Connect the PE to the Grounding terminal
- Keep the wiring box clean

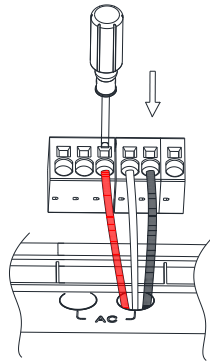

Fig 6.12

### 6.5.2 Connecting the AC output power cable for BACKUP

- Strip 0.7 inches (18mm) of the AC cable insulation.
- Insert the AC conduit into the AC-side drill guide that was opened
- Insert the 0.8\*4.0 mm standard flat-blade screwdriver and press the release mechanism and open the clamp
- Connect the cable to the appropriate terminal blocks according to the labels on the terminal blocks(L1,L2,of Backup)
- Insert the cable into the round opening and remove the screwdriver, then the cable is automatically clamped
- Connect the PE to the Grounding terminal
- Keep the wiring box clean

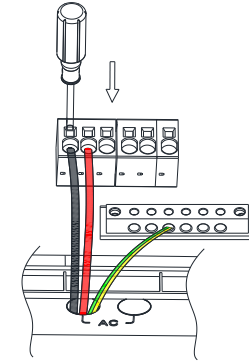

Fig 6.13

### 6.5.3 ATS-US connection



NOTICE

- The ATS-US is used for backup storage function.
- Before the ATS-US connection need to install a secondary AC panel for backup loads. Rewire the backup loads through this panel.
- Cables connecting between the ATS-US and AC panel refers to ATS-US installation manual.

Cables connecting between the ATS-US and MIN TL-XH US inverter

ATS-US	Inverter	Type	Conductor cross-sectional area range
L1(EPS input)	L1(backup)	solid or stranded wire but not fine stranded wire	12-4 AWG
L2(EPS input)	L2(backup)		

- Open the ATS cover
- Remove the hole tapes for installing conduit
- Insert AC backup conduit
- Insert the 0.8\*4.0 mm standard flat-blade screwdriver and press the release mechanism and open the clamp
- Connect the cable to the appropriate terminal blocks according to the labels on the terminal blocks (L1, L2, of Backup)
- Insert the cable into the round opening and remove the screwdriver, then the cable is automatically clamped
- Connect the PE to the Grounding terminal
- Keep the ATS-US box clean

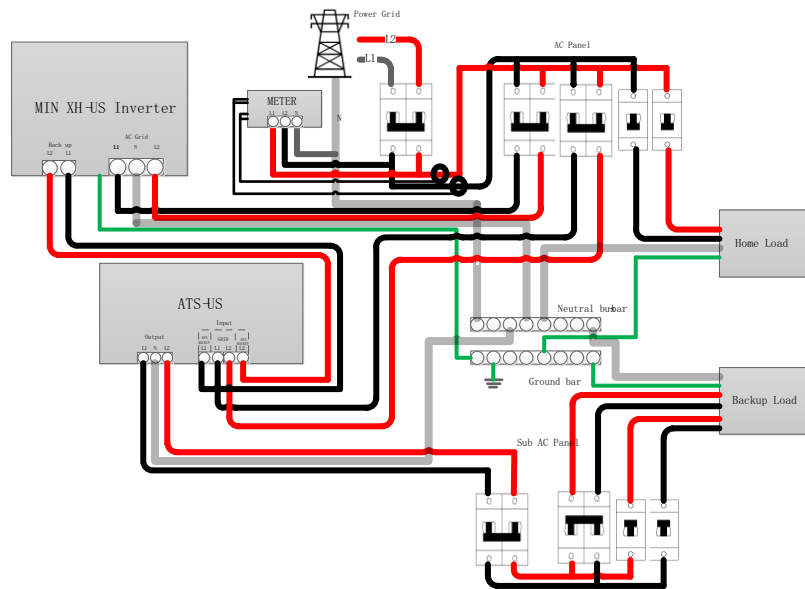





Fig 6.14

 <b>DANGER</b>	<ul style="list-style-type: none"> <li>➤ The output wiring terminals of PV modules or any other connected MLPE device may have hazardous voltages. Touching the terminals may cause electric shock. Before connecting PV input power cables, ensure that the DC switch is OFF and that the DC input terminals have no voltage.</li> <li>➤ When the inverter is running, don't connect or disconnect PV string or PV module in a PV string, due to the risk of electric shock.</li> <li>➤ To ensure maximum protection against hazardous contact voltages while assembling photovoltaic installations, both the positive and the negative leads must be strictly isolated electrically from the protective ground potential (PE).</li> <li>➤ Risk of electric shock and fire. Use only with PV modules with a maximum system voltage of rating of 600V or Higher.</li> </ul>
 <b>WARNING</b>	<ul style="list-style-type: none"> <li>➤ Improper operation during the wiring process can cause fatal injury to operator or unrecoverable damage to the inverter. Only qualified personnel can perform the wiring work.</li> <li>➤ The positive and negative cables of PV strings are connected to PV positive(+) and negative(-) terminals respectively.</li> <li>➤ Since the inverter is transformer-less, the PV string connected to the inverter cannot be grounded, ensure that the PV module output is well insulated to ground</li> </ul>

 <b>NOTICE</b>	<ul style="list-style-type: none"> <li>➤ You can connect systems with multiple PV strings in parallel to the PV input terminals, each MPPT tracker have two string input terminals</li> <li>➤ If more strings are required, they can be connected in parallel using an external combiner box before connecting to the input terminals.</li> <li>➤ When connecting multiple independent strings, it is recommended to run separately.</li> <li>➤ These series inverters have Max. four MPPT,4-mppt independent operating.do not connect two string into 3mppt,it cannot work well.</li> </ul>
--	--

- Strip 0.59 inches (15mm) of the battery cable insulation.
- Insert the conduit into the left side DC-side drill guide that was opened.
- Insert the 0.6\*3.5 mm standard flat-blade screwdriver and press the release mechanism and open the clamp.
- Connect the cable to the appropriate terminal blocks according to the labels on the terminal blocks(PV+1/2/3/4,PV-1/2/3/4).
- Insert the cable into the round opening and remove the screwdriver, then the cable is automatically clamped.
- Connect the PE to the Grounding terminal.
- Keep the wiring box clean.

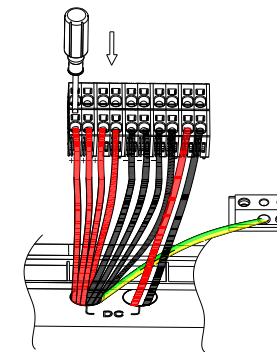





Fig 6.15

### 6.7 Battery connection

Cable	Battery	Inverter	Type	Conductor cross-sectional area range
Negative line of the power cable	-	BAT-	solid or stranded wire but not fine stranded wire	12-8 AWG
Positive line of the power cable	+	BAT+		
Communications cable	EN-GND	Enable-	CAT5/6 standard cables have eight wires (four twisted pairs)	N/A
	ENABLE-H	Enable+		
	RS485_H	485A		
	RS485_L	485B		

### 6.7.1 Power cable connection

 <b>DANGER</b>	<ul style="list-style-type: none"> <li>➤ Battery short circuits may cause personal injury. The high transient current generated by a short circuit will release a surge of energy and may even cause fire.</li> <li>➤ To prevent the risk of electric shock, do not connect or disconnect battery cables when the inverter is running.</li> <li>➤ Before connecting battery cables, ensure that the DC switch on the inverter and all the switches connecting to the inverter are in the OFF position, and the inverter contains no residual electricity. Otherwise, the high voltage of the inverter and battery may result in electric shock.</li> <li>➤ Exposure to battery voltage can result in serious injury. Use dedicated insulation tools to connect cables.</li> </ul>
 <b>WARNING</b>	<ul style="list-style-type: none"> <li>➤ A battery switch and DC fuse can be configured between the inverter and the battery to ensure that the inverter can be safely disconnected from the battery. The recommended DC fuse type is littelfuse KLKD 600V/30A. Make sure the battery positive cable connecting to positive fuse holder and positive pole of the switch in series, the battery negative cable connecting to negative fuse holder and negative pole of the switch in series</li> <li>➤ Make sure the battery cable is connected correctly. That is, the positive and negative terminals of the battery connect to the positive battery terminal and negative battery terminal on the inverter respectively</li> <li>➤ Do not connect loads between the inverter and the battery. Since the inverter is transformer-less, the battery connected to the inverter cannot be grounded, ensure that the battery output is well insulated to ground</li> </ul>
 <b>NOTICE</b>	<ul style="list-style-type: none"> <li>➤ The cable distance between the battery and the inverter should be less than or equal to 10 meters, ideally less than 5meters</li> <li>➤ If the power cables are not installed or routed as required, the positive or negative terminal of the battery may be short-circuited to ground ,an AC or DC short circuit may occur and damage the inverter</li> </ul>

- Strip 15mm(0.59 inches) of the battery cable insulation.
- Insert the conduit into the right-side DC-side drill guide that was opened.
- Insert the 0.6\*3.5 mm(0.02\*0.14 inch) standard flat-blade screwdriver and press the release mechanism and open the clamp.
- Connect the cable to the appropriate terminal blocks according to the labels on the terminal blocks(BAT+,BAT-).
- Insert the cable into the round opening and remove the screwdriver, then the cable is automatically clamped.
- Keep the wiring box clean.

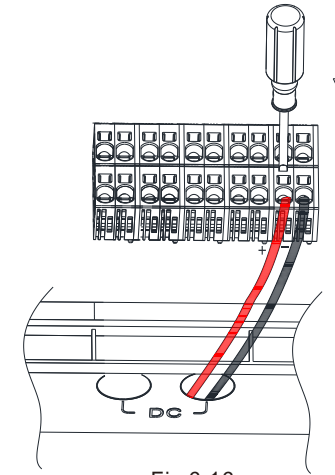
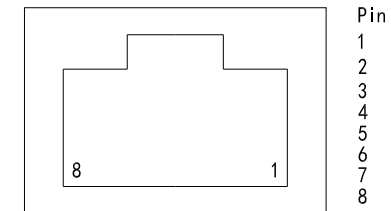

Fig 6.16

### 6.7.2 Signal cable connection

The name of the terminal for battery signal cable connection is shown below, the terminal is standard RJ 45, and the signal cable is the CAT5/6 cable.

#### Connector pin assignment



Top View

Fig 6.17

Rj45 Pin #	Wire Color		Signal	Function
	T568B	T568A		
1	White/Orange	White/Green	Enable+	Battery wake-up signal
2	Orange	Green	Enable-	
3	White/Green	White/Orange	CANL	Battery CAN communication
4	Blue	Blue	CANH	
5	White/Blue	White/Blue	GND	GND
6	Green	Orange	Received	NC
7	White/Brown	White/Brown	RS485B	Battery RS485 communication
8	Brown	Brown	RS485A	

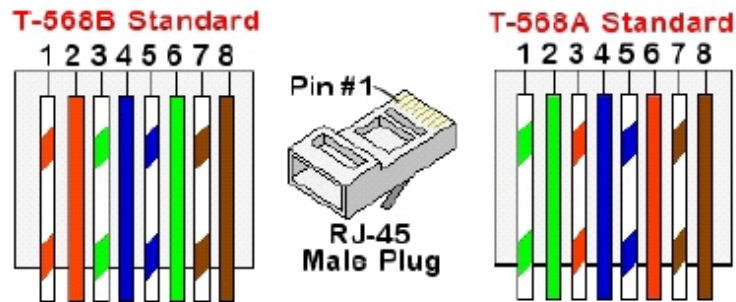

Fig 6.18 Standard cable wiring

CAT5/6 standard cables have eight wires (four twisted pairs), as shown in the diagram below. Wire colors may differ from one cable to another. You can use either wiring standard, as long as both sides of the cable have the same pin-out and color-coding.

- Insert the conduit into the right side COM drill guide that was opened.
- Insert the CAT 5/6 cable through the conduit to the inverter wiring box.
- Remove the cable's external insulation using a crimping tool or cable cutter and expose eight wires.
- Insert the eight wires into an RJ45 connector, as described in Fig 6.18.
- Use a crimping tool to crimp the connector.
- Connect the signal cable from the battery to the RJ45 port on the communication board.
- Keep the wiring box clean.

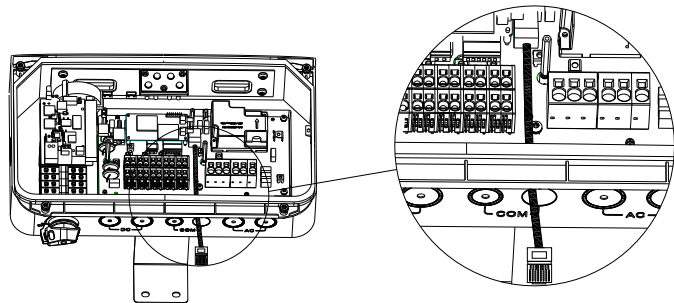

Fig 6.19

### 6.8 Energy Meter connection

The energy meter connection is required to get information about energy flow. Before connecting the energy meter to this product, install the energy meter. Refer to the installation manual of the Energy Meter for more information about energy meter installation.

#### 6.8.1 Cable connection

Cable	Meter	Inverter	Type	Conductor cross-sectional area range
AC wire-L1	$\Phi L1$	N/A	solid or stranded wire but not fine stranded wire	22-18 AWG
AC wire-L2	$\Phi L2$			
AC wire-N	N			
Ground	PE symbol	N/A	N/A	N/A
CT- $\Phi L1$	L1 CT +/-			
CT- $\Phi L2$	L2 CT +/-			
Communications cable	RS485 A+ RS485 B-		Min. 3-wire shielded twisted pair	0.2- 1 mm <sup>2</sup> / 24-18 AWG

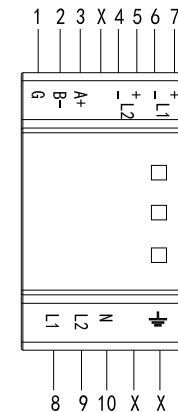

Fig 6.20 Energy Meter Terminal



NOTICE

- Clamp the CT connected to L1 CT around the wire connected to  $\Phi L1$ .
- Clamp the CT connected to L2 CT around the wire connected to  $\Phi L2$ .
- Ensure that the source of current transformers arrow points to the load.

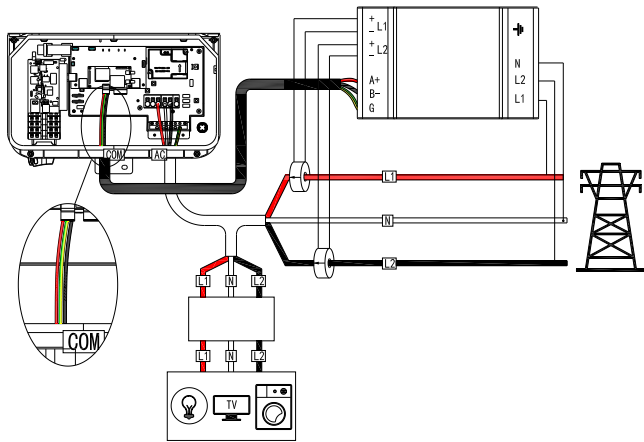

Fig 6.21 Energy Meter connection

### 6.8.2 Energy Meter troubleshooting

LED	LED color	Function	Indication	Troubleshooting
RUN	Green	Flashing ON/OFF (for 1sec)	Work normally	/
	Red	ON for>3sec	Internal error	Contact support
	Yellow	Flashing ON/OFF (for 1sec)	No communication	Check that the communication wires are connected correctly
L1/L2	Green	ON for>3sec	NO Current	/
	Green	Flashing ON/OFF (for 1sec)	Positive power	/
	Red	Flashing ON/OFF (for 1sec)	Negative power	Check for reversed CTs, swapped CT wires, or CTs not matched with the lines
		Flashing with green LED	High voltage>130V	Check the line voltages and the meter rating
		Flashing with yellow LED	Low voltage<70V	
	Yellow	Flashing ON/OFF (for 1sec)	Break fault<30V	Check for the presence of high noise
ON for>3sec		Frequency is below 45Hz or above 70Hz		

## 6.9 Communication connection

### 6.9.1 RS485 BUS communication connection

The MIN TL-XH-US series inverters offer an Modbus RS485 communication interface, the RS485 option enables creating a bus of connected inverters, consisting of up to 31 follower inverters and 1 leader inverter or 1 gateway or datalogger. Using this option, inverters are connected to each other in a bus by daisy chained, via their RS485 connectors.

RS485 wiring specifications:

Cable type: Min. 3-wire shielded twisted pair (a shielded Ethernet cable (Cat5/5E STP) may be used).

Wire cross-section area: 0.2- 1 mm<sup>2</sup>/ 24-18 AWG (a CAT5 cable may be used)

Maximum nodes: 32

Maximum distance between first and last devices: 1 km /3300 ft.

The following sections describe how to physically connect the RS485.

- Insert the conduit into the right side COM drill guide that was opened.
- Insert the cable through the conduit to the inverter wiring box.
- Remove the cable's external insulation using a crimping tool or cable cutter and expose wires.

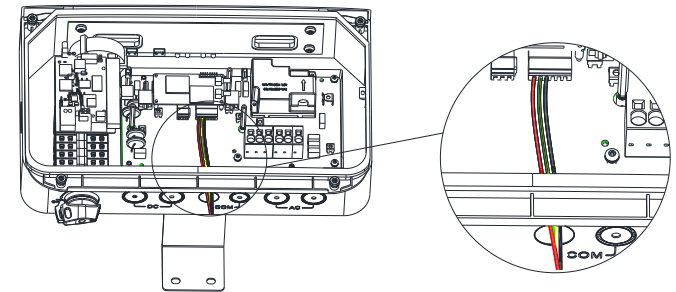

Fig 6.22 The location of RS485 BUS

- Loosen the screws of the 6-pin RS485 terminal block connector.
- Insert the wires into the RS485A2, GND, RS485B2 pins shown below. Use four or six wire twisted pair cable for this connection. The same color wire is used for all A2 pins, the same color for all B2 pins and the same color for all GND pins. The wire for GND is not necessary.

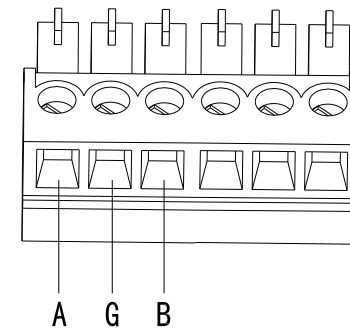

Fig 6.23 RS485 terminal block

➤ For creating an RS485 bus-connect all RS485A2, RS485B2 and GND pins in all inverters. The following figure shown this connection:

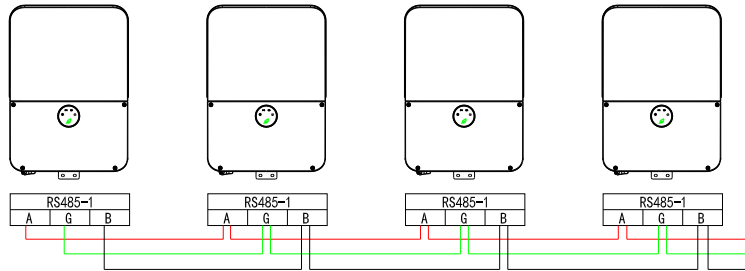

Fig 6.24 Connecting the inverters in Daisy chain

 <b>NOTICE</b>	➤ Don't Cross-connect RS485A2,B2 and GND wire.
	➤ Don't Cross-connect RS485-1,RS485-2.
	➤ The wire for GND is not necessary.

- Tighten the terminal block screws, check that the wires are fully inserted and cannot be pulled out easily.
- Push the RS485 terminal block firmly all the way into the connector on the communication board.
- Keep the wiring box clean.

### 6.9.2 LAN (Ethernet) communication connection (optional)

The MIN TL-XH US series inverter offer an LAN connection option to connect the inverter to the monitoring platform. The optional wireless communication module is Wi-Fi/LAN.

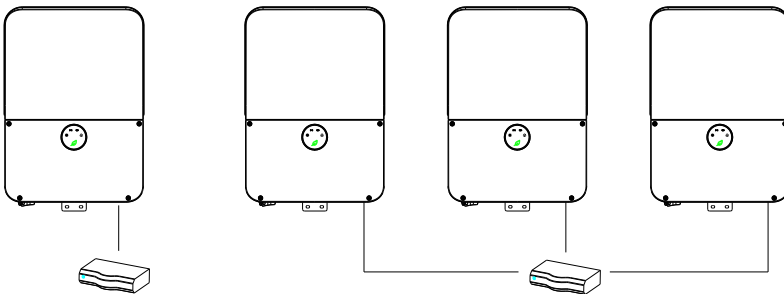

Fig 6.25

LAN wiring specifications:

- Wire type: a shielded Ethernet cable (Cat5/5E STP) may be used
- Maximum distance between the inverter and the router is 100 m/ 330 ft.

RJ45 Pin #	Wire Color		10Base-T Signal 100Base-TX Signal
	T568B	T568A	
1	White/Orange	White/Green	Transmit+
2	Orange	Green	Transmit+
3	White/Green	White/Orange	Receive+
4	Blue	Blue	Receive
5	White/Blue	White/Blue	Receive
6	Green	Orange	Receive-
7	White/Brown	White/Brown	Receive
8	Brown	Brown	Receive

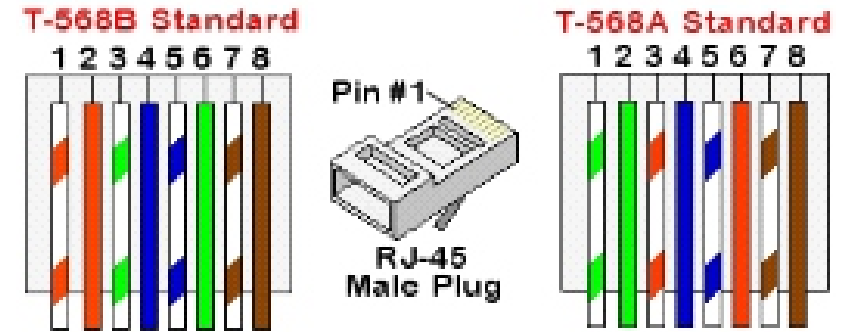





Fig 6.26 Standard cable wiring

CAT5/6 standard cables have eight wires (four twisted pairs), as shown in the diagram above. Wire colors may differ from one cable to another. You can use either wiring standard, as long as both sides of the cable have the same pin-out or color-coding.

- Insert the conduit into the left- side COM drill guide that was opened.
  - Insert the CAT 5/6cable through the conduit to the inverter wiring box.
  - Remove the cable's external insulation using a crimping tool or cable cutter and expose eight wires
  - Insert the eight wires into an RJ45 connector, as described in Fig 6.26.
  - Use a crimping tool to crimp the connector.
  - Connect the signal cable from the router to the RJ45 port on the left-side of communication board.
  - Keep the wiring box clean.
- You can connect more than one inverter to the same switch/router or to different switches/routers as needed. Each inverter sends its data independently to the Growatt monitoring platform.

# 7 Commissioning

 <b>DANGER</b>	High voltages in the PV system Risk of death or serious injury due to electric shock Only electrically skilled persons may perform work on the PV array
 <b>WARNING</b>	Under any condition, make sure the maximum open circuit voltage of each PV string is less than 600Vdc Read all of these instructions, cautions, and warnings for the MIN TL-XH US series inverter and associated PV array documentation. Installation and commissioning must be performed by a licensed electrician in accordance with local, state, and National Electrical Code ANSI/NFPA 70 requirements
 <b>CAUTION</b>	Disconnect in the "OFF" position, verify the PV input polarity once more simply by carefully using a 600 V, DC rated digital volt meter and probing the positive (+) and negative (-) PV array connections.

## 7.1 Checking Before Power-On

No.	Check Item	Acceptance Criteria
1	Inverter installation	The inverter is installed correctly, securely, and reliably
2	Antenna installation	The antenna is installed correctly, securely, and reliably.
3	Cable layout	Cables are routed properly as required by the customer.
4	Cable tie	Cable ties are secured evenly, with no sharp protrusions.
5	Grounding	The ground cable is connected correctly, securely, and reliably.
6	Switches	The DC switch and all the switches connecting to the MIN TL-XH US are in the OFF position
7	Cable connections	The AC output power cable, DC input power cable, battery cable, and signal cable are connected correctly, securely, and reliably.
8	Unused terminals and ports	Unused terminals and ports are fitted with waterproofing bolts or watertight caps.
9	Cable routing pipe sealing	All cable routing pipes at the bottom of the enclosure are sealed.
10	Cleanliness in the maintenance compartment	The maintenance compartment interior is clean and tidy
11	Installation environment	An appropriate installation space has been chosen, and the installation environment is clean and tidy.

## 7.2 Powering on the system

- Before turning on the AC switch between the power grid with MIN TL-XH US inverter, check that the AC voltage on the power grid side of the AC switch is within the specified range.
- Turn on the AC switch/breaker between the power grid with MIN TL-XH US inverter. (Optional)if there is an optional breaker on the PV side, turn on the breaker.
- ⊘ Turn on the DC switch at the bottoms of the MIN TL-XH US inverter.
- If the battery terminal connects to the batteries, turn on the battery power switch and then the battery switch. Also if there is an optional breaker on the battery side, turn on the breaker.
- Perform quick setting and set the MIN TL-XH US inverter parameters on the local tool function of Shinephone APP. for details, see the Operations on the Shinephone APP.
- Observe the LEDs to check the MIN TL-XH US operating status.





## 7.3 LED description

There are four LEDs in the cover of wiring box, from left to right, it is used for indicating status of POWER, COMM, BAT. and FAULT.



Fig 7.1

### 7.3.1 LED Status

Label	Designation	Color
	Power(POWER)	Green
	Wireless communication(COMM)	Green
	Battery(BAT)	Green
	Fault(FAULT)	Red

### 7.3.2 LED description

The single LED indicates the operational status of inverter.

LED Designation	Color	Status	Action	Message
POWER	Green	ON	steady	Feed in grid
	Green	Blink	3s on/1s off	DC ON/AC OFF
	Green	Blink	1s on/3s off	DC OFF/AC ON
	Green	Blink	0.5s on/0.5s off	synchronizing with grid
	Green	Blink	2s on/2s off	standby mode
COMM	Green	ON	steady	BAT is in normal operation
	Green	Blink	1s on/3s off	BAT is in low power
	Green	Blink	0.5s on/0.5s off	BAT is in fault mode
	Green	Blink	1s on/1s off	BAT interal comm. Fail
	Green	Blink	2s on/2s off	BAT is in standby mode
	Blank	ON	steady	No BAT , PV inverter mode
BAT	Green	ON	steady	4G/WiFi,local WiFi ok
	Green	Blink	0.5s on/0.5s off	Local WiFi connecting
	Green	Blink	1s on/1s off	WiFi/ 4G fail,Local WiFi ok
	Green	Blink	1s on/3s off	Local WiFi fail,4G/WiFi ok
	Blank	ON	steady	Comm. Fail
FAULT	Red	ON	steady	Arc Fault(with the buzzer on)
	Red	Blink	1s on/1s off	Warning
	Red	ON	steady	Fault

The LED combination indicate the operational status of inverter.

LED Designation	Color	Status	Action	Message
POWER	Green	ON	In sequence	DSP Firmware Update
BAT	Green	ON		
COMM	Green	ON		
FAULT	Red	ON	1s on/1s off	M3 Firmware Update
POWER	Green	Blink		
BAT	Green	Blink		
COMM	Green	Blink		
FAULT	Red	Blink	3s on/1s off	Backup mode
POWER	Green	Blink		
BAT	Green	ON		
BAT	Green	Blink	1s on/1s off	BAT internal comm. Fai
COMM	Green	Blink		

### 7.4 Powering off the system

**WARNING**

- After the inverter powers off, the remaining electricity and heat may still cause electric shock and burns. After power-off, wait 5 minutes before servicing the inverter. Always wear protective gloves when servicing the inverter.
- If the inverter is connected to the battery, ensure that a shutdown command is sent from the APP. Power off the system after the inverter has shut down. If no shutdown command is sent from the app, the inverter will shut down after the power grid is off, the inverter will wait for meanwhile, then charge the battery by solar power and the inverter enter off grid mode.
- Power off both Grid, PV and Battery totally, can shut down the system.

- Send a shutdown command from the APP. for details, see the Operations on the Shinephone APP.
- Turn off the AC switch between the inverter and the power grid.
- Turn off the DC switch at the bottom of the inverter.
- If a battery connects to the battery port of the inverter, power off the battery.
- The system is shutdown.

### 7.5 Button

#### 7.5.1 Reset button

There is a button located inside the wiring box. for this button,there are the The following functions are for reset button:

Button	Application	Trigger condition
Arc reset	Clear arc fault	Press the button for 3-5 seconds
Arc self-test	If there is no arc fault, run arc self-test	Press the button for 3-5 seconds
Gateway reset	Gateway reset to factory status	Press the button for more than 10 seconds

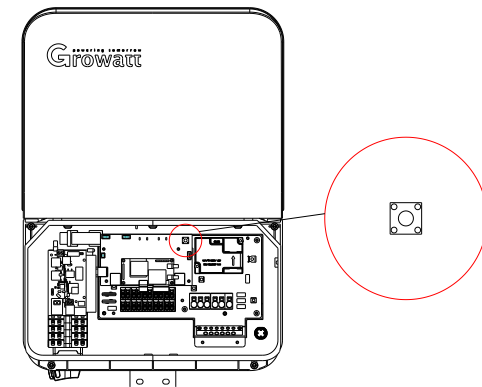

Fig 7.2



### 7.5.2 Blackout dark start button

Button	Application	Trigger condition
Dark start	During grid outage, when the whole system shutdowns for some reason, and can't recover by itself. Press this button to wake up battery or the whole system.	Press the button for more than 5 seconds.

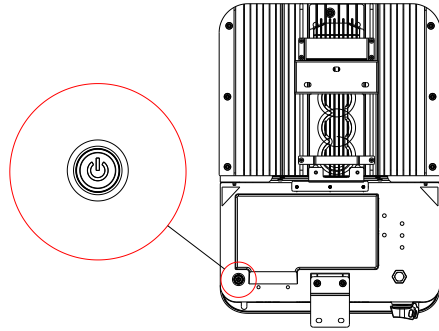

Fig 7.3

## Operations on the Shinephone APP 8

### 8.1 Overview

The Shinephone APP is a mobile phone app that can locally communicate with the MIN TL-XH US over WiFi to allow for real-time status monitoring, system mode management, performing routine maintenance, and commissioning.

After the PV or Power Grid side of the MIN TL-XH US is energized, the APP can connect to the inverter in either of the following ways:

➤ The mobile phone connects to the local WiFi generated by the MIN TL-XH US directly, it is used for Local Tool.

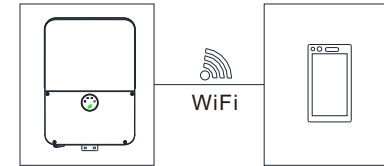

Fig 8.1 Mobile phone connecting to the inverter local WiFi

➤ The mobile phone connects to the MIN TL-XH US inverter through a router. Do not use this method for the first login. Ensure that the inverter has connected to the router if you need to use this method. It is used for remote and mobile monitoring and setting.

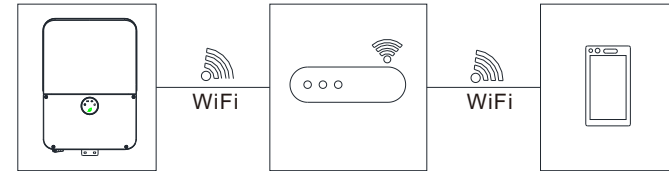

Fig 8.2 Mobile phone connecting to the inverter via a router

### 8.2 APP Download

There are two ways to download the ShinePhone APP.

➤ Scan the QR code



Fig 8.3 ShinePhone downloading QR code

Scanning the QR code with the WeChat sweep function, then download the APP APP Store

Search for Shinephone from one of the following app stores in the following list, download the installation package, and install the Shinephone app by following the instructions.

- Google Play (Android)
- App store (iOS)
- Website

Log in to our monitoring website <http://server-us.growatt.com> to download.

After the app is installed, the ShinePhone icon is displayed on the home screen.



Fig 8.4 Tap the ShinePhone icon to access the home screen of the app.

## 8.3 APP Introduction

### 8.3.1 Home screen of the APP

ShinePhone supports multiple languages. APP language automatically switches according to the user's mobile language.

### 8.3.2 Local tool

You can choose to configure the local debugging tool by clicking the tool below the login interface. There are real-time device control and device information function.

## 8.4 Connecting to the inverter local Wi-Fi network

Connecting to the inverter local Wi-Fi to allow for real-time status monitoring, system mode management, performing routine maintenance, and commissioning. It's also the first step in remote network configuration. Let's talk about how to connect the local WIFI.

1) The DC or AC side of the inverter has been energized.

2) Open the APP and click on the local commissioning, then click on the MIN/MIC button, then choose the "TL-XH-US". There will be prompt information at this time, tell us to connect to the local WIFI.

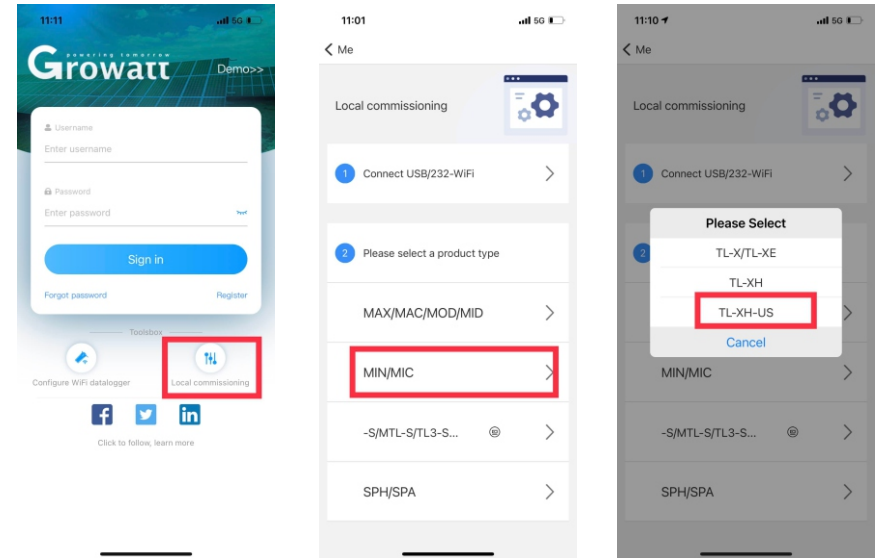

Fig 8.5

3) Open the Wi-Fi function on the mobile phone.

4) Choose the inverter's local WIFI to connect, The WIFI name is the S/N numbers on the label on the left side of the inverter, The password is 12345678.



Fig 8.6

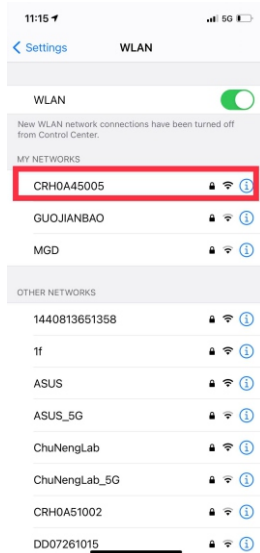

Fig 8.7

When connecting to the inverter local Wi-Fi from the mobile phone, keep the mobile phone visible within 3 meters of the inverter ensure the communication quality between the Phone and the inverter.

## 8.5 Configuring the WIFI network

### 8.5.1 Quick setting

After you log in the Local tool successfully, the Home screen is displayed. You can tap in the Auto refresh icon, If there is data, it means the connection is successful. If not, then reconnect the local WIFI. Then start configuring the network.

1) tap in the quick setting icon, Then choose the with default password.

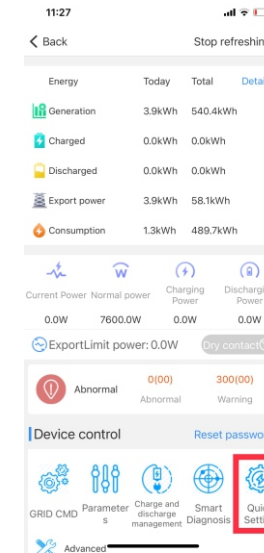
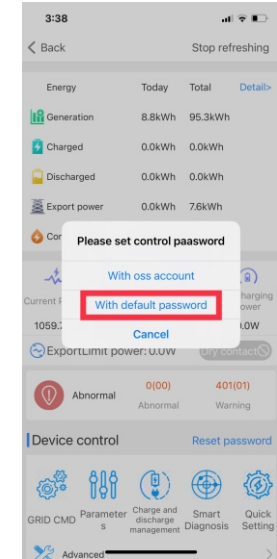

Fig 8.8



2) Enter the default password, the default password is oos+tadoy, like oss20201229.

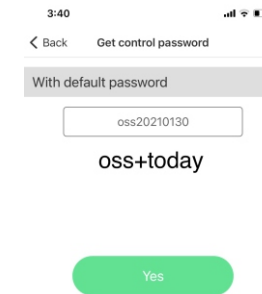

Fig 8.9

3) Set your own password, like 123, you have to remember this password.

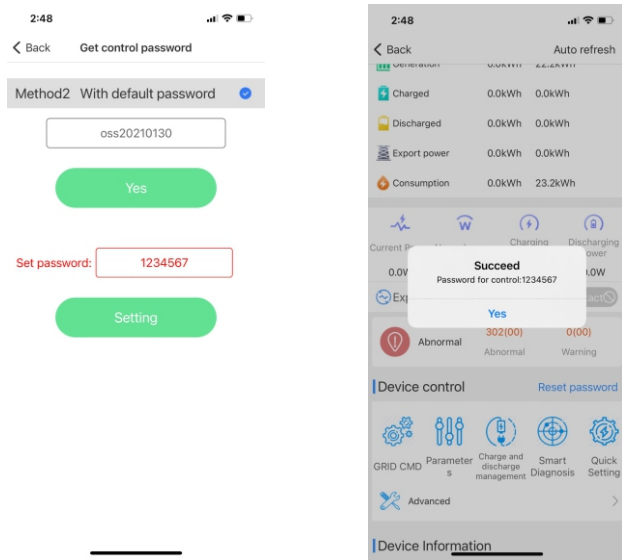

Fig 8.10

4) Tap in the quick setting icon again, Enter the password you just set 123.

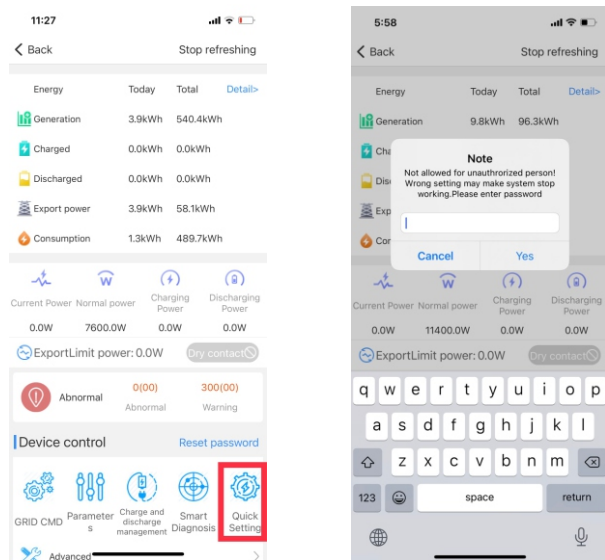

Fig 8.11

5) Tap in the Config Wifi icon, enter the config page. In this page, enter the right information. The router name and password are your house WIFI name and password. The hostname and server both enter the "server-us.growatt.com".

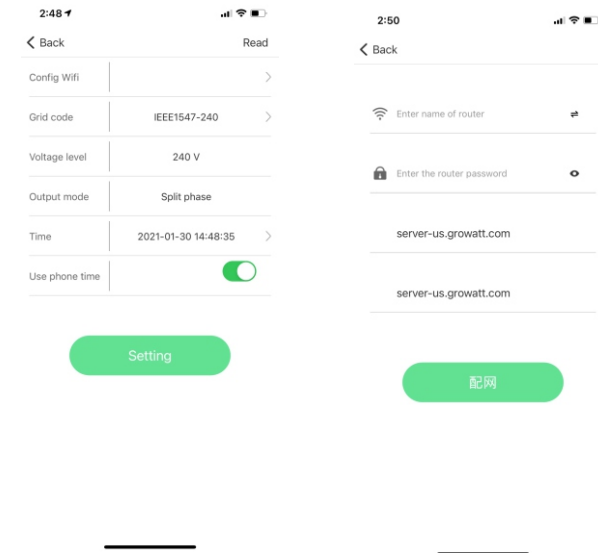

Fig 8.12

6) After finishing this, tap in the setting icon and waiting, if failed, try again.

After configuring the WIFI network, we can use the server and the remote monitoring and setting function.

## 8.6 ESS Mode setting

ESS has four working modes: unrestricted mode, export only mode, import only mode and no exchange mode, here are the steps to set four modes.

- 1) connect to the inverter local Wi-Fi from the mobile phone, follow the method described above.
- 2) tap in the charge and discharge management icon again, Enter the password you just set above.
- 3) Then choose 1. Time Slot Priority setting, enter the setting page.

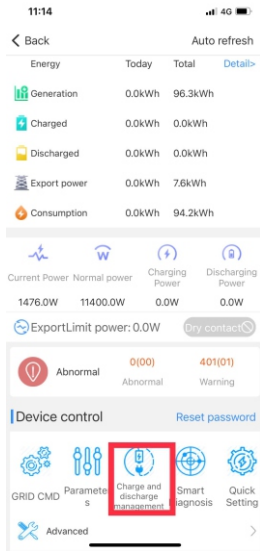

Fig 8.13

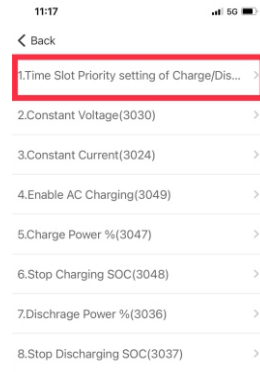

Fig 8.14

4) In this page, we can setting the ESS Mode, there are many choose boxes. The quarter, month, enable, week, time period, ESS mode.

- First, choose the quarter you want to set, Enable box choose enable, Enter the month number to the start and end box, Check in the small box behind, Slip down the bottom of the page, tap in the setting icon.

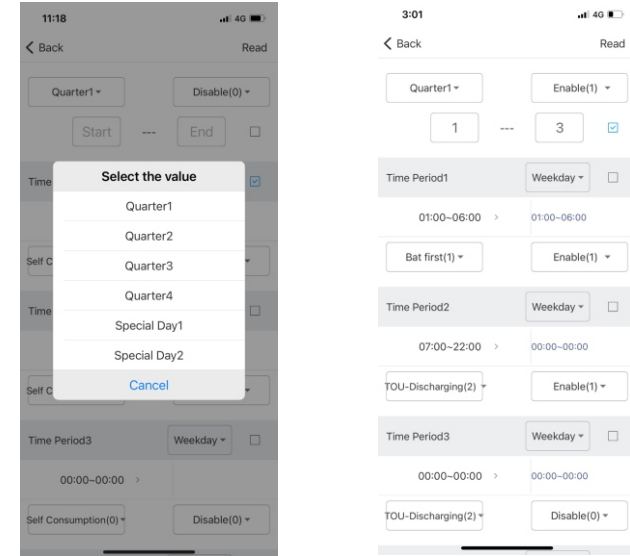

Fig 8.15

- Choose the week choice, choose the time period you want, then choose the ESS mode you want to set. Enable box choose enable.

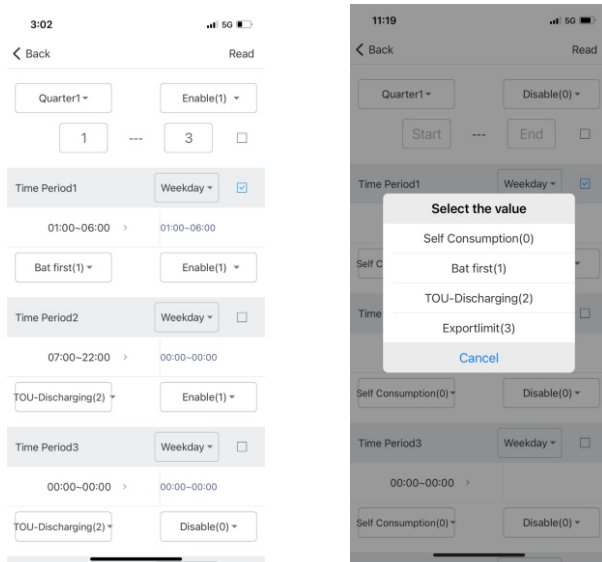

Fig 8.16

- Example for setting, When finishing the setting, We can tap in the read to check whether the settings are successful.

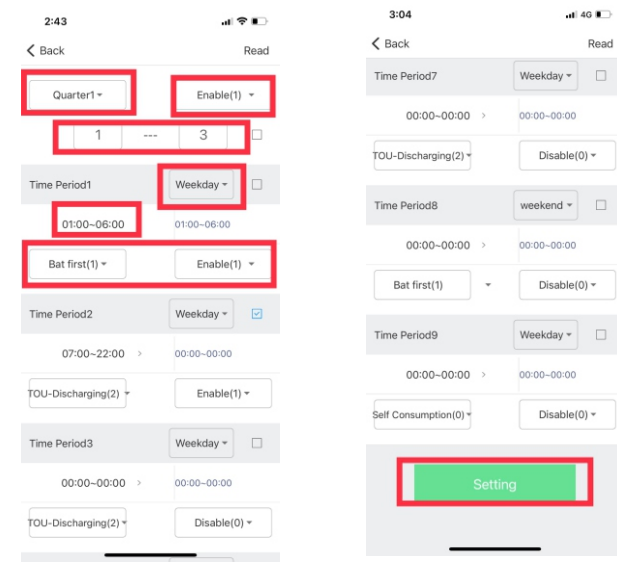

Fig 8.17

Setting Mode	Ess Mode
Self consumption	Unrestricted mode
BAT first	Export only mode
TOU-Discharge	Import only mode
Exportlimit	No exchange mode

# 9 Information browsing and parameter setting

When we log in to the APP and connect to the local WIFI, Then we can browse and set the inverter information, This procedure has been introduced in the previous chapter.

## 9.1 Inverter information browsing

On the main page, we can see the main power generation information of the inverter. For further detailed information, We can tap in the icon in the upper right corner to view.

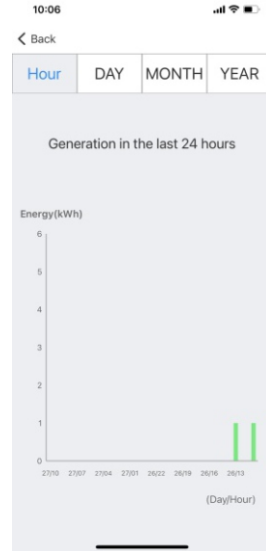
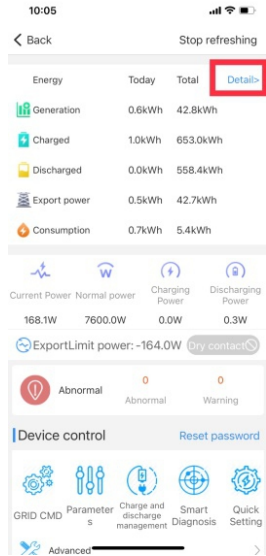

Drag the screen down, we can see more inverter information. Contains PV input information, grid-side information, battery-related information, software version information, and other information.

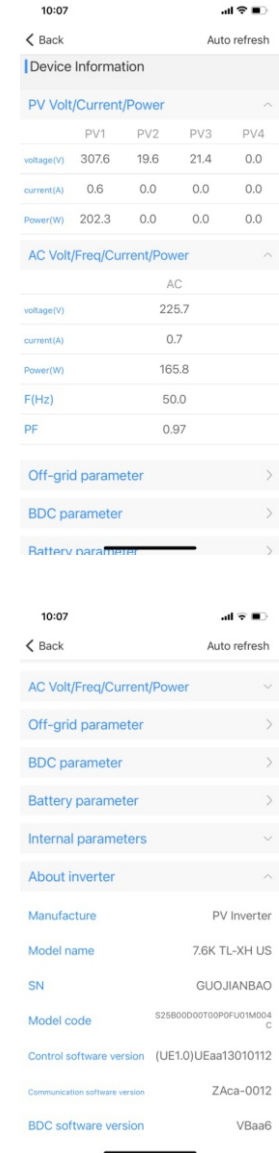
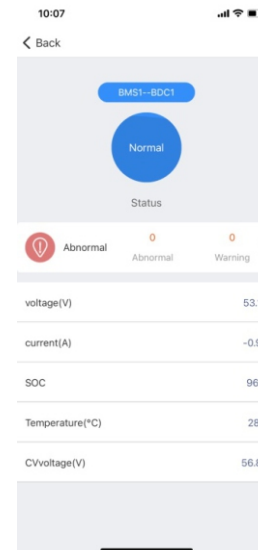
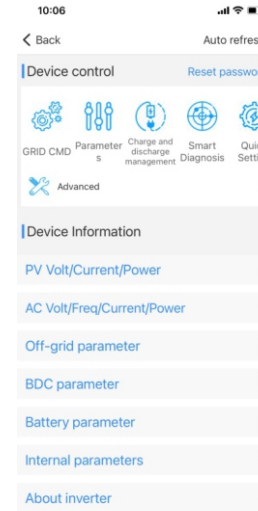

## 9.2 Inverter parameters setting

Through this APP, in addition to viewing the detailed information of the inverter, We can also set the parameters of the inverter system. The content of the setting is divided into five aspects: GRID CMD, Parameters, Charge and discharge management, smart Diagnosis, Quick Setting. We can tap in these icons to enter the internal setting interface.

### 9.2.1 GRID CMD setting

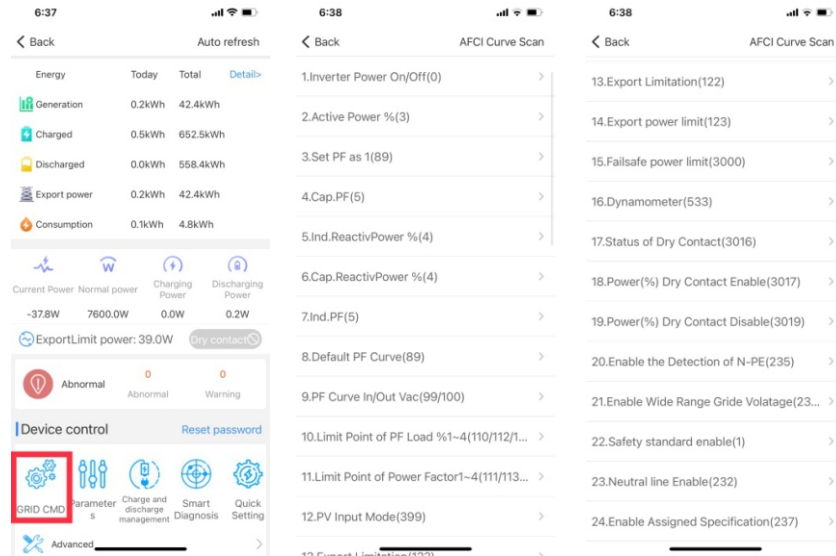

Setup steps introduction: When we need to set a item, such as active power, We can tap in this, and then it will jump to the setting interface. If you want to get the current setting information, tap in Read in the upper right corner. If you need to set new content, fill in the information you want to set in the upper input box, and then tap in the Setting below.

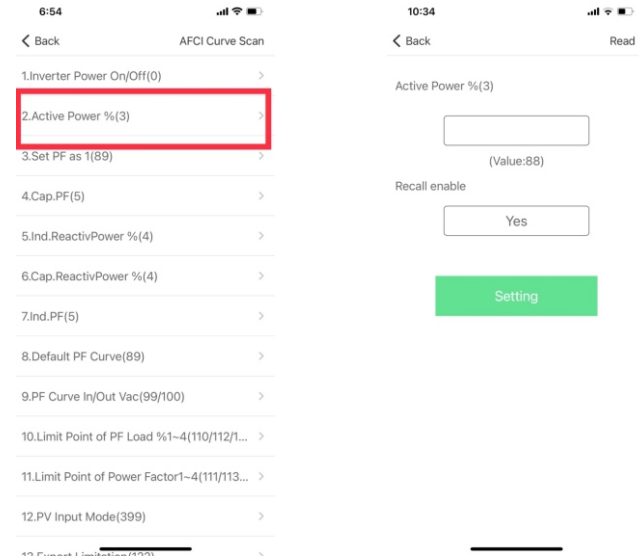

There are many other functions that can be set here, and the setting methods are the same.



### 9.2.2 Parameters setting

After tapping in the parameter button, enter the detailed setting interface, There are many setting options here, we can choose the items that need to set, and the setting method is the same as that described above. for example,if we want to set the Ramp Rate,tap in the option,enter the setting interface, Tap in read to view the current information, then enter the content that needs to be set in the input box, and finally tap in Setting.

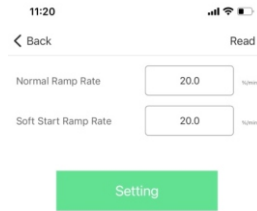
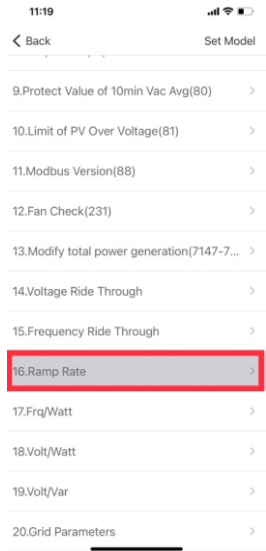

### 9.2.3 Charge and discharge management setting

Charge and discharge management is only for the system with battery, The setting items inside are all related to battery charging and discharging, The setting method of each option is the same as the previous one.

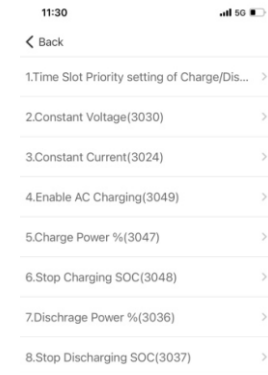
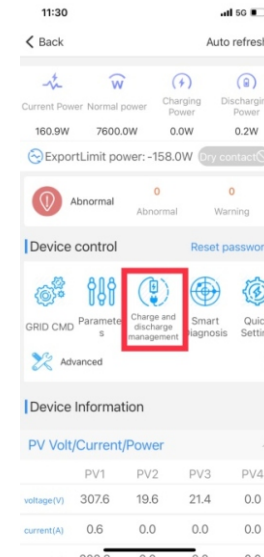

If you need to know more details, you can contact the manufacturer by phone or email.

# 10 Power Control System Introduction

The MIN 3000-11400TL-XH US inverter can form a power control system(PCS) with other parts. The PCS is divided into two types: DC coupled system and an AC coupled system. The PCS includes inverter, battery and smart meter. The diagram of the PCS is shown in the figure below.

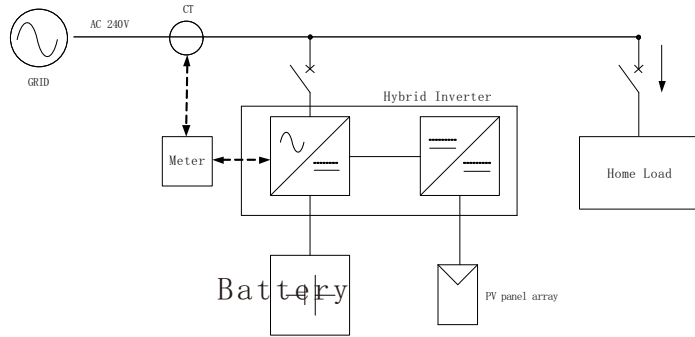

Fig 9.1 DC Coupled System

Part	Model	Quantity
Hybrid Inverter	MIN 3000-11400 TL-XH US	1
Battery	ARO 6.6-19.8L-C1-US	1
Meter	SM-US-200	1

Four parts of the PCS system can be purchased from our company. The detailed parameters and installation instructions of the parts can refer to the manual of the parts. The manual can be downloaded from the official website of the company. When you buy the parts, there will be a manual in the package of the parts.

**Notice:** Ensure that the source of current transformers' arrow points to the load.

# Cleaning and Care 11

## 11.1 Checking the inverter

If the inverter regularly reduces its output power due to high temperature, please improve the heat dissipation condition. Maybe you need to clean the heat sink.

## 11.2 Checking the DC disconnect

Check for externally visible damage and discoloration of the DC Disconnect and the cables at regular intervals. If there is any visible damage to the DC Disconnect, or visible discoloration or damage to the cables, contact the installer. Once a year, turn the rotary switch of the DC Disconnect from the On position to the Off position 5 times in succession. This cleans the contacts of the rotary switch and prolongs the electrical endurance of the DC Disconnect.

## 11.3 Cleaning the Inverter

If the inverter is dirty, turn off the AC breaker and DC switch, waiting for the inverter to shut down, then clean the enclosure lid, the display, and the LEDs using only a wet cloth. Do not use any cleaning agents (e.g. solvents or abrasives).

## 11.4 Troubleshooting

Sometimes, the PV Inverter does not work normally, we recommend the following solutions for common troubleshooting. The following table can help the technician to understand the problem and take action.

### 11.4.1 Error Messages displayed on LED and APP

An error message will be displayed on the LED screen when a fault occurs. The faults consist of system fault and inverter fault.

You may be advised to contact Growatt in some situation, please provide the following information.

Information concerning the inverter:

- Serial number
- Model number
- Error message on LED
- Short description of the problem
- Grid voltage
- DC input voltage
- Can you reproduce the failure? If yes, how?
- Has this problem occurred in the past?
- What was the ambient condition when the problem occurred?

Information concerning the PV panels:

- Manufacturer name and model number of the PV panel
- Output power of the panel
- Voc of the panel
- Vmp of the panel
- Imp of the panel
- Number of panels in each string

If it is necessary to replace the unit, please ship it in the original box.

### 11.4.2 System fault

System fault (system faults are mainly caused by system instead of inverter, please check the items as instructed below before replacing inverter).

Error message	Description	Suggestion
Residual I High Error: 201	Leakage current too high	1.Restart the invert. 2.If error message still exists, contact Growatt.
PV Voltage High Error: 202	The DC input voltage is exceeding the maximum tolerable value.	1.Disconnect the DC switch immediately. 2. Check the voltage of each PV string with multimeter. 3.If the voltage of PV string is lower than 550V, contact Growatt.
PV Isolation Low Error: 203	Insulation problem	1.Check if panel enclosure ground properly. 2.Check if inverter ground properly. 3.Check if the DC breaker gets wet. 4.Check the impedance of PV (+) & PV (-) between ground (must be more than 25 K $\Omega$ or 550K $\Omega$ (VDE 0126)). If the error message is displayed despite the above checking passed, contact Growatt.
AC V Outrange Error: 300	Utility grid voltage is out of permissible range.	1.Please switch off DC switch. 2.Check AC wiring, especially neutral and ground wire. 3.Check grid voltage is complied with local grid standard. Restart inverter, if problem still exist, Contact Growatt.
No AC connection Error: 302	No AC connection	1.Check AC wiring. 2.Check the status of AC breaker
AC F Outrange Error: 304	Utility grid frequency out of permissible range.	1.Please switch off DC switch. 2.Check AC wiring, especially neutral and ground wire. 3.Check grid frequency is complied with local grid standard. Restart inverter, if problem still exist, Contact Growatt.
PE abnormal Error: 303	Voltage of Neutral and PE above 30V.	1.Check the voltage of Neutral and PE. 2. Check AC wiring. 3.Restart inverter, if error message still exists,contact Manufacturer
Auto Test Failed Error: 407	Auto test didn't pass.	Restart inverter, repeat Auto Test, if problem still exist, contact Growatt.

### 11.4.3 Inverter warning

Warning code	Meanings	Suggestion
Warning 203	PV1 or PV2 Circuit short	1. Check the PV panel polarity. 2. Restart the inverter. If the warning still exist, please contact Growatt customer service to replace the POWER board.
Warning204	Dryconnect function abnormal	1. After shutdown, Check the dry Dryconnect wiring. 2. If the error message still exists, contact manufacturer
Warning 205	PV1 or PV2 boost broken	Restart the inverter. If the warning still exist, please contact Growatt customer service to replace the power board.
Warning207	USB over-current	1. Unplug the U disk or monitor. 2. Re-access U disk or monitor after shutdown. 3. If the error message still exists, contact manufacturer.
Warning 401	Inverter communicates with Meter abnormal	1. Check if the meter is on. 2. Check the inverter and the meter connection is normal.
Warning404	EEPROM abnormal	Restart the inverter. If the warning still exist, please contact Growatt customer service to replace the M3 board.
Warning405	Firmware version is not consistent	Uptate the right version firmware

# Decommissioning 12

## 11.4.4 Inverter fault

Error code	Meanings	Suggestion
Error: 402	Output High DCI	Restart inverter, if problem still exist, contact Growatt
Error: 404	Bus sample fault	Restart inverter, if problem still exist, contact Growatt
Error: 405	Relay fault	Restart inverter, if problem still exist, contact Growatt
Error: 408	Over Temperature	If the ambient temperature of inverter is lower than 60°C, restart inverter, if error message still exists, contact Growatt.
Error: 409	Bus over voltage	Restart inverter, if problem still exist, contact Growatt.
Error: 411	DSP communicates with M3 abnormal	Restart inverter, if problem still exist, update the DSP&M3 firmware; change DSP board or M3 board, if problem still exist, contact Growatt
Error: 414	EEPROM fault.	Restart inverter, if problem still exist, contact Growatt.
Error: 417	The data sampled by the DSP and redundant M3 is not the same.	Restart inverter, if problem still exist, contact Growatt.
Error: 420	GFCI fault.	Restart inverter, if problem still exist, contact Growatt.

## 12.1 Dismantling the Inverter

 <b>CAUTION</b>	Danger of burn injuries due to hot enclosure parts! Wait 20 minutes before disassembling until the housing has cooled down.
---	--

1. Disconnect the inverter as described in section 6.
2. Remove all connection cables from the inverter.
3. Screw off all projecting cable glands.
4. Lift the inverter off the bracket and unscrew the bracket screws.

## 12.2 Packing the Inverter

If possible, always pack the inverter in its original carton and secure it with tension belts. If it is no longer available, you can also use an equivalent carton. The box must be capable of being closed completely and made to support both the weight and the size of the inverter.

## 12.3 Storing the Inverter

Store the inverter in a dry place where ambient temperatures are always between -22°F to 149°F (-30°C to 65°C).

## 12.4 Disposing of the Inverter



Do not dispose of faulty inverters or accessories together with household waste. Please accordance with the disposal regulations for electronic waste which apply at the installation site at that time. Ensure that the old unit and, where applicable, any accessories are disposed of in a proper manner

# Growatt Warranty 12

Please refer to the warranty card.

# 13 Technical Data

## 13.1 Specification

Model	MIN 3000TL- -XH-US	MIN 3800TL- XH-US	MIN 5000TL- XH-US	MIN 6000TL- -XH-US	MIN 7600TL- XH-US
Input data(PV)					
Max. recommended PV power(for module STC)	4500W	5700W	7500W	9000W	11400W
DC/AC Ratio	1.5				
Max. DC voltage	600V				
Startup voltage	50V				
Nominal voltage	360V				
Operating MPPT range	50~550V				
No. of MPP trackers	2			3	
No. of PV strings per MPP trackers	2/2			2/2/2	
Max. input current per MPP trackers	12.5A				
Max. short-circuit current per MPP trackers	16.6A				
Input/Output Data (Battery)					
I/O Voltage range	360V~550V				
Nominal DC Voltage	360V				
I/O DC Current	15A				
I/O DC Power	5000W				
Battery Technology	LFP				
Battery Capacity per module	9.9kWh				
Scalability	Up to 4				

Output data(AC)					
AC nominal power @240V AC	3000W	3800W	5000W	6000W	7600W
Max. AC apparent power	3000VA	3800VA	5000VA	6000VA	7600VA
Nominal AC voltage	208V/240V				
AC voltage range @208V AC @240V AC	183V~229V 211V~264V				
AC grid frequency	50/60Hz				
AC grid frequency range	45~65Hz				
Max. output current	12.5A	16A	21A	25A	32A
Power factor(@nominal power)	>0.99				
Adjustable power factor	0.8 leading~0.8 lagging				
THDi	<3%				
AC grid connection type	L1/L2/N/PE				
Output Data(Backup)					
AC nominal power@240V	3000W	3800W	5000W	5000W	5000W
Max AC Powe Output	3680VA	4000VA	5000VA	6000VA	6000VA
Nominal AC Voltage	240V/208V				
Rated. Output Current	16A		21A		
PCS controlled current setting	0~ 16 A		0~ 21 A		
THD@RCD load	5%				
Efficiency					
Max. efficiency	98%	98%	98.2%	98.40%	98.40%
CEC efficiency	97%	97%	97.50%	97.50%	98%
Protection devices					
DC reverse-polarity protection	Integrated				

DC switch	Integrated
DC Surge protection	Type II
AC surge protection	Type III
AC short-circuit protection	Integrated
Ground fault monitoring	Integrated
Grid monitoring	Integrated
Anti-islanding protection	Integrated
Residual-current monitoring unit	Integrated
AFCI protection	Integrated
General data	
Dimensions (W / H / D)	16.43*21.65*6.69 inch(425*550*170mm)
Weight	39.68 lbs(18kg)
Operating temperature range	-13°F(-25 °C ~ +60 °C) de-rating above 113°F
Noise emission (typical)	≤ 35 dB(A)@3 ft
Altitude	9842ft(3000m)
Internal consumption at night	<1W(For PV Inverter) <5W(For Storage Inverter)
Topology	Transformerless
Cooling	Natural Convection
Electronics protection degree	NEMA4X (IP65)
Relative humidity	0~95%
DC connection	Spring Contact Type
AC connection	Screw terminals
Interfaces	
Display	LED
RS485	Integrated

WIFI/ 4G	Optional
Warranty: 10 / 12 years	yes/optional
RSD(NEC2017 690.12)	Integrated
Revenue Grade Meter	ANSI C 12.20(meet 0.5% accuracy)
Certification	
Grid support regulation	IEEE1547, CA Rule21, Rule14(HECO Compliant)
EMC	FCC Part15 Class B
Safety	UL1741, UL1741SA, CSA C22.2, UL1998, UL1699B, UL1741 CRD

Model	MIN 8200TL -XH-US	MIN 9000TL- XH-US	MIN 10000TL- XH-US	MIN 11400TL -XH-US
Input data(PV)				
Max. recommended PV power(for module STC)	12300W	13500W	15000W	17100W
DC/AC Ratio	1.5			
Max. DC voltage	600V			
Startup voltage	50V			
Nominal voltage	360V			
Operating MPPT range	50~550V			
No. of MPP trackers	4			
No. of PV strings per MPP trackers	2			
Max. input current per MPP trackers	13.5A			
Max. short-circuit current per MPP trackers	16.9A			
Input/Output Data (DC)				
Battery	350V~480V			
Nominal DC Voltage	400V			
I/O DC Current	15A			
I/O DC Power	5000W			
Battery Technology	LFP			
Battery Capacity per module	9.9kWh			
Scalability	Up to 4			

Output data(AC)				
AC nominal power @240V AC	8200W	9000W	10000W	11400W
Max. AC apparent power	8200VA	9000VA	10000VA	11400VA
Nominal AC voltage	208V/240V			
AC voltage range @208V AC @240V AC	183V~229V 211V~264V			
AC grid frequency	50/60Hz			
AC grid frequency range	45~65Hz			
Max. output current	35A	38A	42A	48A
Power factor(@nominal power)	>0.99			
Adjustable power factor	0.8 leading~0.8 lagging			
THDi	<3%			
AC grid connection type	L1/L2/N/PE			
Output Data(Backup)				
AC nominal power	10000W			
Max AC Powe Output	11400VA			
Nominal AC Voltage	240V			
Max. Output Current	47A			
PCS controlled current setting	0~ 21 A			
THD	5%			
Efficiency				
Max. efficiency	98.50%			
CEC efficiency	98.00%			
Protection devices				
DC reverse-polarity protection	Yes			

DC switch	Yes
DC Surge protection	Type II
Insulation Resistance	Yes
AC surge protection	Type III
AC short-circuit protection	Yes
Ground fault monitoring	Yes
Grid monitoring	Yes
Anti-islanding protection	Yes
Residual-current monitoring unit	Yes
AFCI protection	Yes
General data	
Dimensions (W / H / D)	15.8*25.2*7.4 inch(400*638*187mm)
Weight	45.2 lbs(20.5kg)
Operating temperature range	-13°F(-25 °C ~ +60 °C) de-rating above 113°F
Altitude	9843ft(3000m)
Internal consumption at night	<1W(For PV Inverter) <5W(For Storage Inverter)
Topology	Transformerless
Cooling	Natural Convection
Electronics protection degree	NEMA4X (IP65)
Relative humidity	0~95%
DC connection	Spring Contact Type
AC connection	Screw terminals
Interfaces	
Display	LED
RS485	Integrated

WiFi/ 4G	Optional
Warranty: 10 years	yes(optional for extended 15 and 20
Revenue Grade Meter	ANSI C12.20(meet 0.5% accuracy)
Certification	
Grid support regulation	IEEE1547,CA Rule21,Rule14(HECO Compliant)
EMC	FCC Part15 Class B
Safety	UL1741,UL1741SA,CSA C22.2,UL1998,UL1699B,UL1741 CRD

### 13.2 Efficiency curve

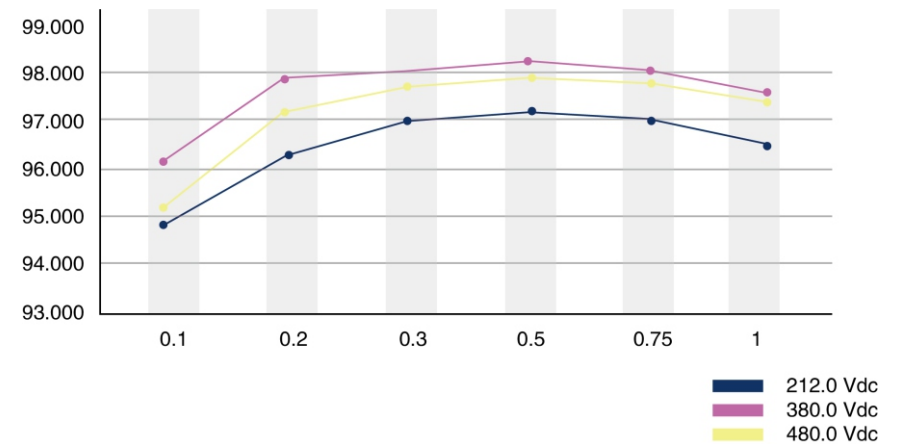

Fig 12.1



## 13.3 Ambient temperature

The inverter can be operated in an ambient temperature from -13°F to 140°F (-25°C to 60°C). The MIN TL-XH-US series inverter operate at full power and full currents up to a certain temperature, above which they may operate with reduced ratings to prevent device damage. The following diagram illustrates how the output power of the solar inverter is reduced automatically in accordance with ambient temperature. The device should be installed in a well-ventilated, cool and dry location. Due to tolerance of temperature sensor and inverter efficiency difference under different PV voltage, this derating curve may be a little different from each.

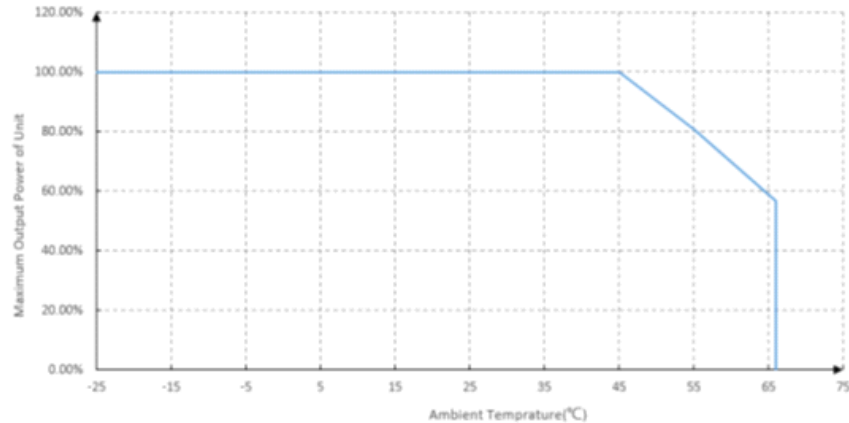

Fig 12.2

If you have technical problems about our products, contact the GROWATT Serviceline. We need the following information in order to provide you with the necessary assistance:

- Inverter type
- Serial number of the inverter
- Event number or display message of the inverter
- Type and number of PV modules connected
- Optional equipment

### Shenzhen Growatt New Energy Co., Ltd

4-13/F, Building A, Sino-German (Europe) Industrial Park,  
Hangcheng Ave, Bao'an District, Shenzhen, China

**T** +86 0755 2747 1942

**E** [service@ginverter.com](mailto:service@ginverter.com)

**W** [www.ginverter.com](http://www.ginverter.com)