

# EP CUBE

## Installation Manual v1.0



## Contents

Introduction.....	4
1. Warranty Registration.....	4
2. Disclaimer.....	4
3. Copyright.....	4
4. Abbreviated Terms.....	5
5. Customer Services Contact.....	5
THE EP CUBE SYSTEM.....	6
1. Standard Components.....	6
A. Hybrid.....	6
B. Smart Gateway.....	7
2. Optional Accessories .....	7
A. Circuit Breaker Kit.....	8
B. CT-Kit.....	8
C. Wall Mounted Kit .....	8
3. System Scenarios.....	9
A. Whole Home Backup.....	9
B. Partial Home Backup.....	9
EP CUBE INSTALLATION .....	10
1. Site Survey.....	10
2. On-site Installation.....	10
3. Installation of Hybrid.....	10
A. Preparation :.....	10
B. Start Installation : .....	12
4. Installation of Smart gateway.....	17
A. Preparation :.....	17
B. Start Installation:.....	18

Wiring & Commissioning.....	21
1. EP Cube system wiring.....	21
A. Wiring from solar panel to Hybrid.....	22
B. Wiring from Hybrid to Smart gateway .....	23
C. Wiring of Grid and Load .....	25
D. Wiring of others.....	29
E. Wiring of emergency stop.....	29
F. Wiring of Hybrid inverter mating connector .....	30
2. EP Cube system commissioning.....	30
A. EP Cube startup .....	30
B. Registration and finish.....	31
IMPORTANT SAFETY INSTRUCTIONS .....	32
1. Safety Notice.....	32
2. Personal Protective Equipment(PPE) .....	33
Appendix.....	34
1. Torque Values.....	34
A. Torque values for fasteners.....	34
B. Torque values for wires. ....	34

## Introduction

This manual describes the installation process and provides a set of guidelines for EP Cube system installers. Please thoroughly read this manual before installation and follow the instructions during the entire installation process. If you have any further queries regarding the product, please contact the EP Cube service team. For more information about the EP Cube products, please refer to the product-specific User Manual and Data Sheet. The safety warnings found in the above-mentioned documents also apply to this manual.

This manual is only valid for the EP Cube series.

 **WARNING: EP Cube products can only be installed, repaired, replaced and maintained by the EP authorized personnel for safety and warranty purposes.**

### 1. Warranty Registration

PRODUCT WARRANTY REGISTRATION IS A VERY IMPORTANT PART OF INSTALLATION. BE SURE TO COMPLETE THE COMMISSIONING PROCESS AND WARRANTY REGISTRATION.

For the detailed warranty policy, please refer to EP Cube LIMITED WARRANTY.

Document link: [www.eternalplanetenergy.com](http://www.eternalplanetenergy.com)

Login to the EP CRM APP to register and ensure system owner information is accurate to complete warranty registration.

Mobile APP download: [www.eternalplanetenergy.com](http://www.eternalplanetenergy.com)

### 2. Disclaimer

This document has gone thru rigorous technical review before being published to provide accurate information. However, EP believes in striving for continuous improvement of our products and specifications may change without prior notice. Thus, it will be revised regularly and any modifications and amendments will be included in subsequent issues. The illustrations and images in this manual are for demonstration purposes only. The responsibility of a safe and quality installation is of the qualified and licensed installation professional. Actual product details may vary in appearance on the installation site.

### 3. Copyright

All rights reserved. The disclosure, duplication, distribution, and editing of this document, or utilization and communication of the content are not permitted unless authorized in writing. All rights, including rights created by patent grant or registration of a utility model or a design, are reserved.

## 4. Abbreviated Terms

<b>ABBR</b>	<b>Description</b>
A	Ampere
AC	Alternating Current
CT	Current Transducer
COMM	Commissioning
DC	Direct Current
EV	Electric Vehicle
kW	Kilowatt
L (L1 L2)	Phase (1,2)
LED	Light-emitting Diode
LRA	Locked Rotor Amps
N	Neutral
RSD	Rapid Shutdown Device
PN	Part Number
PV	Photovoltaic
V	Voltage

## 5. Customer Services Contact

Contact EP via email below:

Email address: [service.us@eternalplanetenergy.com](mailto:service.us@eternalplanetenergy.com)

## THE EP CUBE SYSTEM

The EP Cube system consists of two standard components: the Hybrid and Smart Gateway. In addition to these components, users have a wide range of optional accessories available to choose from according to site and customer-specific needs.

### 1. System Scenarios

#### A. Whole-Home Backup

All home appliances can be powered by the EP Cube when a grid power outage occurs in the whole-home backup topology. With a whole home backup installation, the Smart gateway is installed between the meter and main loads panel.

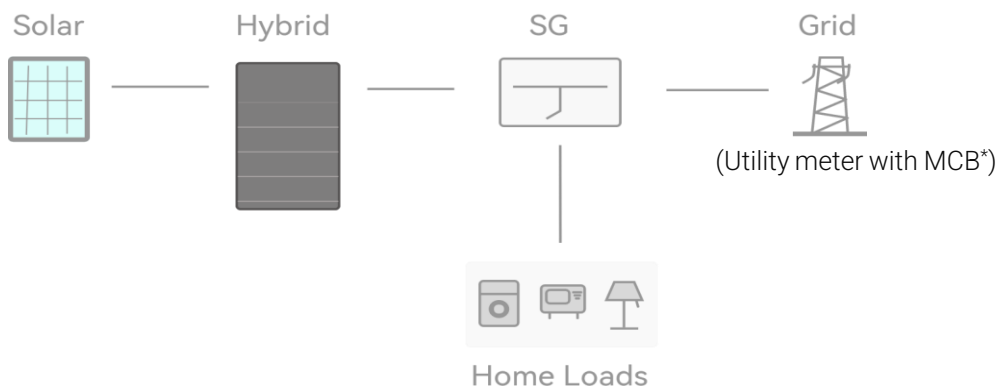

**⚠ NOTE:** \*The main circuit breaker (MCB) is mandatory between Grid and Smart Gateway. If the utility meter doesn't have a circuit breaker (CB) or power panel between the Grid and Smart gateway, an MCB or power panel must be installed at the site.

#### B. Partial-Home Backup

In this type of system layout, the EP Cube manages and optimizes the power supply for part of the property owner's loads. Only the backup loads will be powered when a grid power outage occurs in partial-home backup topology.

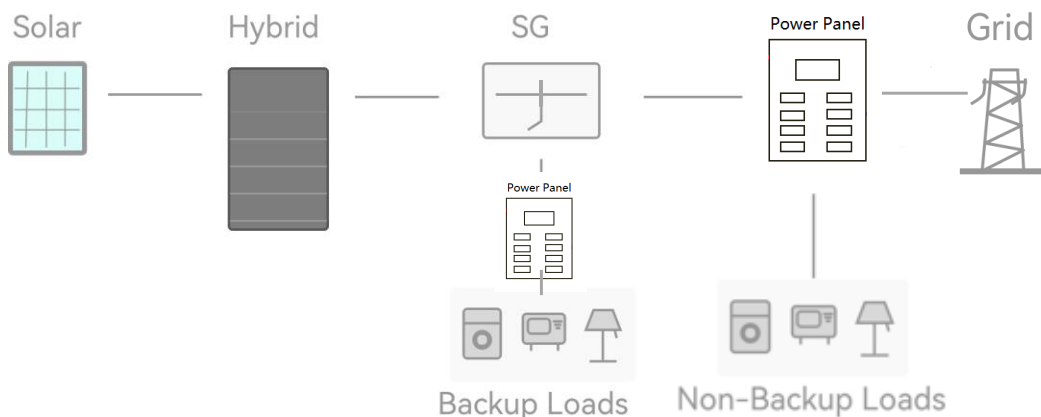

## 2. Standard Components

### A. Hybrid

Hybrid is an integrated battery storage product that includes both Battery Modules and Hybrid Inverter. (Refer to US Specification for more details)

Reference Model:

Standard Hybrid + additional Battery modules\*3Pcs

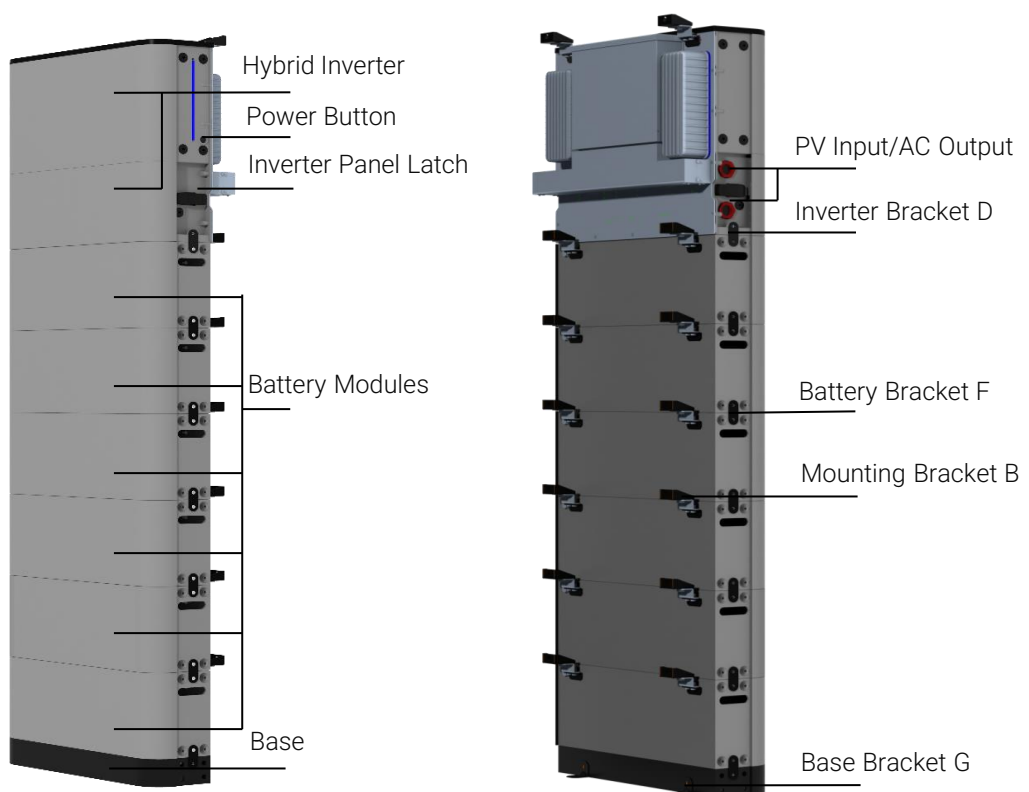

## B. Smart gateway

The Smart gateway works for home power generation and consumption management by connecting with the utility grid, PV Inverter, EP Cube Hybrid, and home appliances. (Ref. to US Specification for more details)

**⚠ Note:** Smart gateway includes a preinstalled circuit breaker for the Hybrid and the control kits for Generator input or AC coupled PV array.

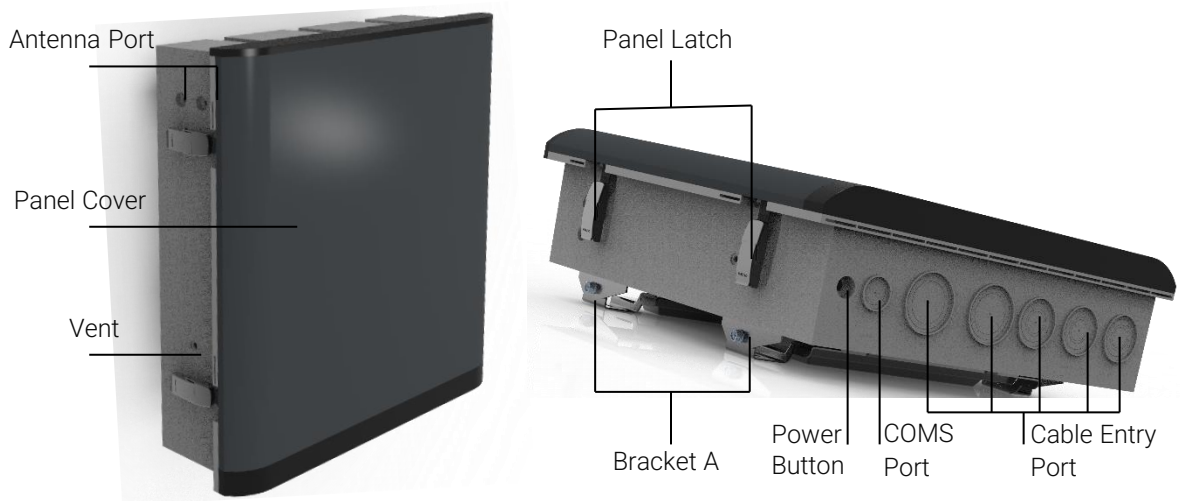

## 3. Optional Accessories

EP Cube optional accessories models

Description	Part Number	Model Name	Note
Circuit Breaker Kit	1005-00011-00	MCBs Kit - NA40ASG	Optional for Smart gateway
CT-Kit	1005-00016-00	CT Kit - NA200SG	
Wall-mount Kit	1005-00023-00	Wall mounted Kit	Optional for Hybrid

### A. Circuit Breaker Kit

Optional circuit breakers may be added to the DIN rail for additional EP Cube Hybrid units. These should only be used when more than one Hybrid system is installed on a site, with a smart gateway.

**Specification:** Max Current : 40A.



## B. CT-Kit

The optional consumption CT kit is for partial-home backup systems to monitor any non-backed up loads.



### Specification:

- Max Current : 200 A
- Length : 32.8'
- Accuracy: 1% of reading

*CT-kit*

## C. Wall-mounted Kit

Optional for Hybrid, used for holding Hybrid and the base mounted to the Wall.

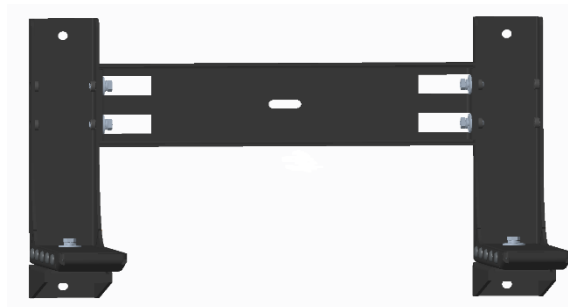

*Wall Mounted Kit*

## EP CUBE INSTALLATION

EP Cube can be mounted on a floor or wall, and comes with floor mounting brackets. For different wall-mounted installations an optional mounting kit should be ordered.

### 1. Site Survey

Complete site information by gathering data through a site survey.

 **CAUTION:** For EP Cube installation on exterior walls or near to the openings (doors, windows), Please refer to applicable local codes and UL 9540 23.2.

For EP Cube indoor installation, Please refer to applicable local codes and UL 9540 42.6.

EP Cube's maximum load start capability is 118A LRA. Authorized installers should analyze and ensure the customer site satisfies this requirement.

Note that the EP Cube Hybrid assembly is heavy! Installers should refer to the specifications for Hybrid weight details and check with local regulations to confirm the wall mounting is viable.

### 2. On-site Installation

 **WARNING :**

EP Cube can only be installed, repaired, replaced, and maintained by the EP authorized personnel for safety and warranty purposes. It is prohibited to install any third-party component or devices inside the EP Cube without prior approval from the EP service team.

For personal protection and property safety, please read the safety chapter and ensure complete compliance during the entire installation process.

Please ensure to avoid the installation of the EP Cube in environments where it is exposed to excessive rain, direct sunlight, dust, flooding, or accumulating snow.

**NOTE:** Wall mounting bolts for brackets A and C need to be provided by the installer and ensure complete compliance with the regional building codes. EP Cube doesn't provide these fasteners.

### 3. Installation of Hybrid

This section introduces the Hybrid assembly and installation process in sequence.

#### A. Preparation :

If the system design requires accessory items or kits, please review each associated instruction set.

Make sure all necessary tools and materials are available before starting the installation process to avoid any inconvenience on site.

**Table 1. Tools**

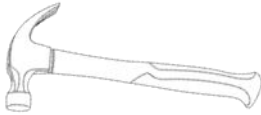

**Hammer**



**Torque Wrench**



**Level Tool**



**Drill Set (with 3/8" drill bit)**

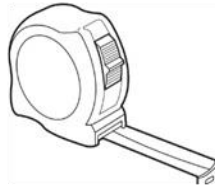

**Tape Measure**

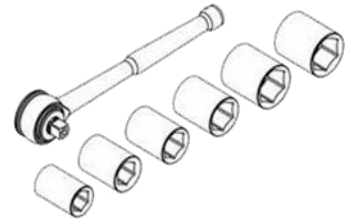

**Socket Wrench Set**

Examine and ensure that the following quantities are correct per placed order, and that no parts were broken or damaged during transportation. You may check off the unpacking inspection guide provided below.

**Table 2. Unpacking view**

- Hybrid Inverter Box:



**Hybrid Inverter\*1 Pcs**



**Side cover A\*1 set**



**Hybrid bracket C\* 1 Pcs**



**Bracket B1\* 2 Pcs**



**M5\*0.47" Bolt\*4 Pcs**

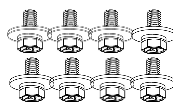

**M6\*0.63" Bolt\*8 Pcs**



**Bracket D\*2 Pcs**



**Bracket B2\*2 Pcs**

Table 2. Unpacking view

- Battery Module Box:



Battery Module\*1 Pcs



Side cover B \* 1 set



Hybrid bracket C\* 1 Pcs



Bracket B1\* 2 Pcs

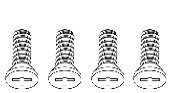

M5\*0.47" Bolt\*4 Pcs

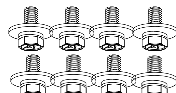

M6\*0.63" Bolt\*8 Pcs



Bracket F\*2 Pcs



Bracket B2\*2 Pcs

- Base Box:



Hybrid Inverter\*1 Pcs



Side cover C\*1 set



Bracket G\* 2 Pcs

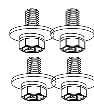

M6\*0.63" Bolt\*4 Pcs

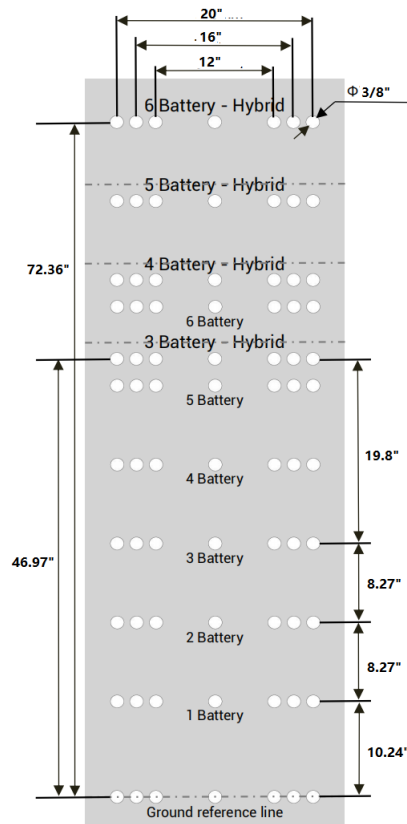

Hybrid Drill template\*1 Pcs

- Optional Bracket Box :



Hybrid bracket C\* 1 Pcs

- Wall mounted kit



Bracket E1\* 2 Pcs

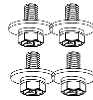

M6\*0.63" Bolt\*4 Pcs

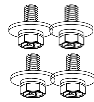

M8\*0.63" Bolt\*4 Pcs



Bracket E2

**B. Start Installation :**

➤ **STEP1 place the drill template on the wall**

- Mark a "start line" by using a tape measure, level tool, and pencil on the wall.
- Cut the extra piece of drill template
- Place the drill template and align it with the "start line".

**⚠ CAUTION:** Please keep a safe distance between the Hybrid and other objects.

**NOTE:**

There should be a minimum of 11" clearance from the Hybrid right and top sides. All other sides should have enough clearance for safe operation and installation and meet the National Electrical Code (NEC) 110.26 requirements.

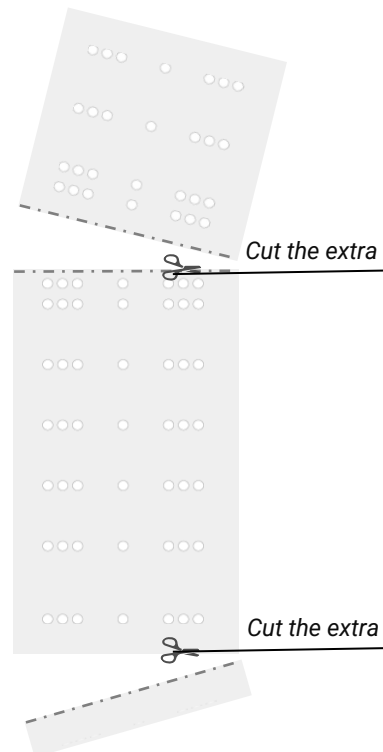

Cut and place the drill template

➤ **STEP2 Locating the mounting holes**

Using a pencil, mark the mounting holes on the wall as indicated by the drill template.

**NOTE:**

Each bracket C needs 2 holes to be installed on the wall. The distance between these 2 holes should be either 12 or 16 or 20 inches. The wall-mounted installation requires one additional bracket C than the floor-mounted installation.

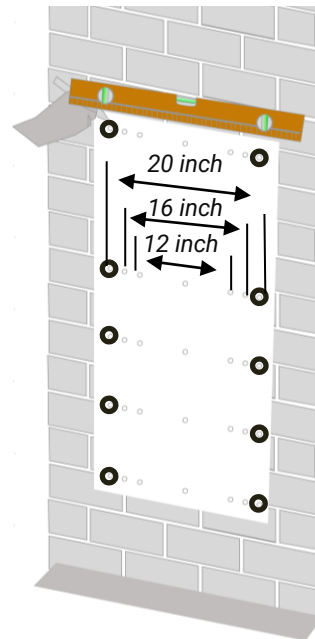

**Mark the mounting holes**

➤ **STEP3 Install the Bracket C on the wall**

- a. Remove the drill template.
- b. Use Bracket C to ensure the holes' positions are correctly matched.
- c. Select anchor bolts or wood screws with washers, and a minimum length of 1-1/2 inches to install Bracket C on the Wall.
- d. Use a level tool to ensure bracket C is level, Tighten the anchor's nut to the specified values. (Ref. to Appendix-Torque Values)

**NOTE:** Select the suitable M8 (or similar) bolt/screw to mount the Bracket C depending on the type of wall.

e.g. for concrete walls use a minimum length of M8\*3-inch anchor bolts. For wooden walls use a minimum thread length of 1-1/2" wood screws.

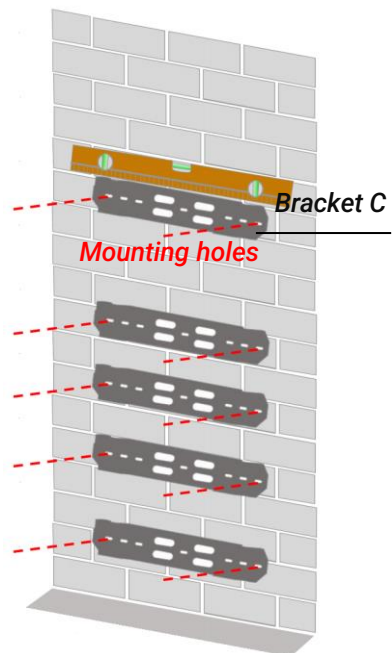

**Install bracket C on wall**

➤ **STEP3 Floor mounted - Install the Base with mounting Bracket G:**

- a. Place the Base on the floor with a minimum distance of 4.13" between the wall and base, or locate the place with the drill template.

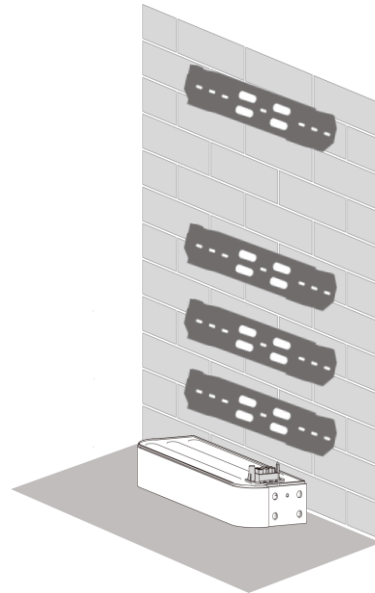

- b. Use the drill set to drill  $\phi 3/8" \times 3"$  holes marked on the floor for Bracket G. Then use a hammer to lightly insert the hex sleeve anchor bolts (M8\*3") into the holes.

- Use the socket wrench to remove the nut and washers. Then place the Bracket G on the floor through hex sleeve anchor bolts.
- Put the nuts and washers back and manually tighten.

- b. Attach the base and Bracket G oval holes using bolts (M6\*0.63").

- c. Measure to ensure that the Base is level using the level tool, then tighten the anchors' nuts to specified torque values. (Ref. to Appendix-Torque Values).

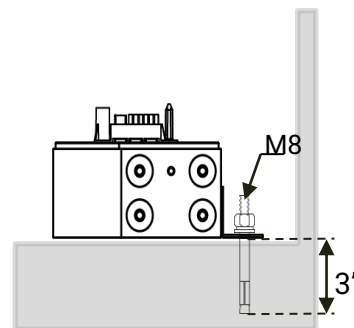
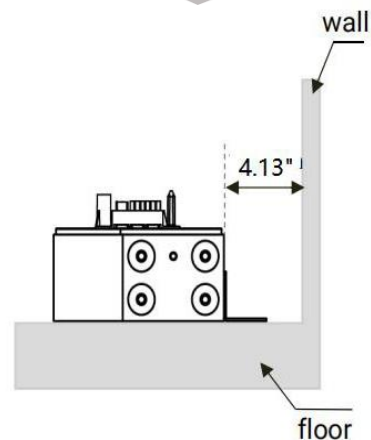

➤ **STEP3 Wall mounted - Install the Base with mount Bracket G and E:**

a. Assemble the Wall-Mounted Kit ( Bracket E ) and check that the mounting holes may match with Bracket C at the same position.

b. Attach Bracket E1 to the Bracket E2 from the left and right sides with the bolts (M6\* 0.63"). Tighten the bolts (M6\* 0.63" ) by using the socket wrench.

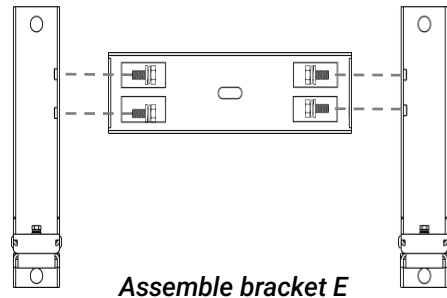

c. Attach the Bracket E to the Bracket C with bolts (M8\*0.79"), check that it is level using the level tool, and then tighten it with the socket wrench.

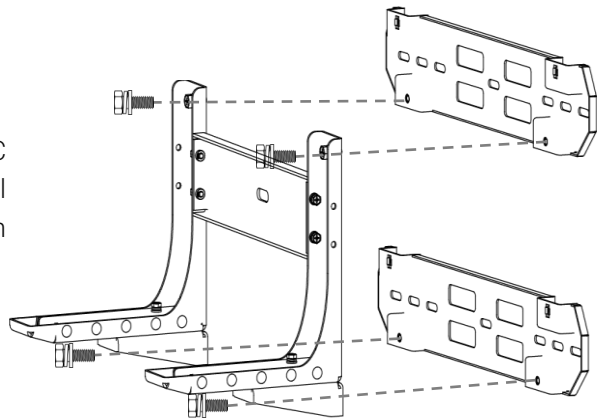

d. Attach the Bracket G oval hole and Base with bolts (M6\*0.63" ), put it on Bracket E, and attach the Bracket G round holes and Bracket E with Bolts( M6\*0.63" ). Verify that the Base is level using the level tool.

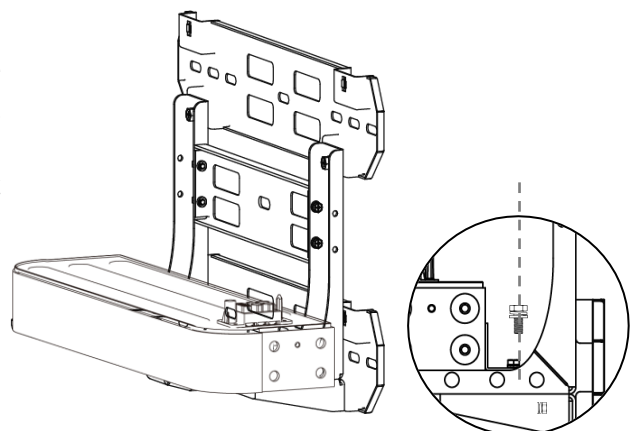



➤ **STEP4 Install the Battery module with brackets B and F**

a. Carefully place the battery on top of the base and connect the sockets well.

**⚠ CAUTION:** The battery module is heavy, Please use lifting tools or multiple people to lift for your own safety. Make sure that the bracket C top screws hole matches with Bracket B1 mounting hole.

b. For Each Battery Module(1-20) :

- Attach Bracket B2 and protruding brace on the back of the battery module using bolts (M6\*0.63"), and manually tighten.
- Attach Bracket B1 to Bracket C with bolts (M6\*0.63"), and manually tighten.
- Attach Brackets B1 and B2 with (M6\*0.63" ) bolts.
- Tighten all bolts and nuts to specified torque values. (Ref. to Appendix-Torque Values).

c. Repeat steps "a and b" to stack the required number of battery modules on top of the base according to the configuration.

d. Install and tighten bracket F :

- Attach Bracket F and all battery modules, on both the left and right sides with the bolts (M5\*0.47").
- Connect and tighten the base and Battery Module one-by-one.

e. Tighten all the bolts to specified torque values. (Ref. Appendix- Torque Values).

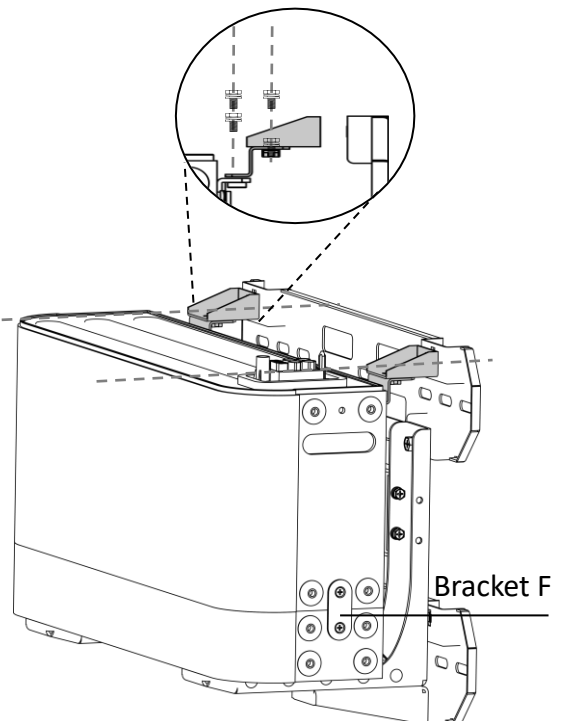
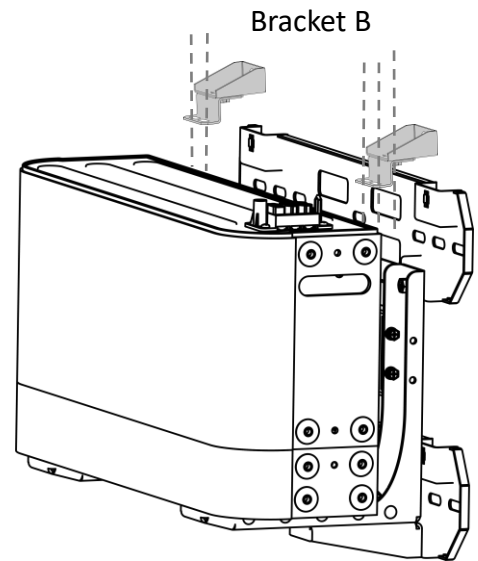

➤ **STEP5 Install the Hybrid Inverter with brackets B & D**

a. Repeat Steps “4. a to 4. b” to stack the Hybrid Invert and install with Bracket B.

- Use a level tool to ensure that the Hybrid inverter is level.
- b. Install and tighten bracket D :
  - Attach the Bracket D and Hybrid inverter using bolts (M5\* 0.47”), both on the left and right sides.
- c. Tighten all the bolts to specified torque values. (Ref. to Appendix-Torque Values).

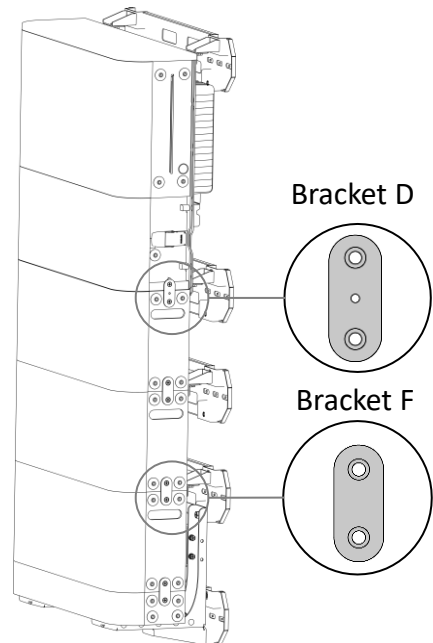

## 4. Installation of Smart Gateway

This section introduces the Smart gateway installation process in sequence.

### A. Preparation :

- Check if there are optional accessories that need to be installed. If so, please install the accessories first.
- Make sure all necessary tools and materials are available before starting installation.

**Table 1. Tools**

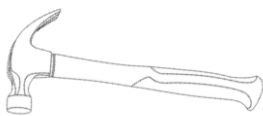

**Hammer**

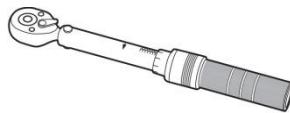

**Torque Wrench**



**Level Tool**



**Drill Set (with 3/8” drill bit)**

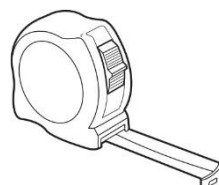

**Tape Measure**

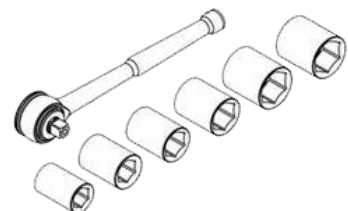

**Socket Wrench Set**

**Table 2. Unpacking view**

Examine and ensure that the following quantities are correct as per placed order, and that no parts were broken or damaged during transportation. You may check off the unpacking view provided below.

**- Smart Gateway Box:**

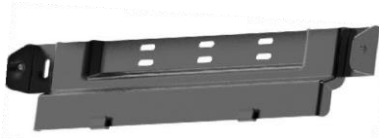

**Smart Gateway bracket A2: 2 PCS**

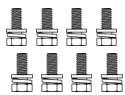

**Bolts: (M5\* 0.55 ")\* 8 PCS**



**Smart Gateway bracket A1: 2 PCS**

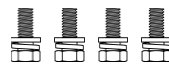

**Bolts: (M8\* 0.63 ")\* 4 PCS**



**Warranty Letter**



**Reference for different type of wall**

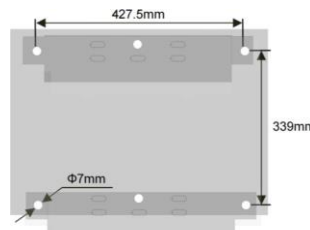

**Smart Gateway drill template: 1 PCS**



**User/Installation Manual**

**B. Start Installation :**

➤ **STEP1 Locating the mounting holes**

a. Mark a "start line" on the installation area by using a tape measure, level tool, and pencil. Align the Smart gateway drill template with the "start line", Then using a pencil, mark the mounting holes on the wall indicated by the Smart gateway drill template.

**⚠ CAUTION:** Please keep enough clearance between the smart gateway and other objects. e.g. On all sides of the smart gateway, the minimum clearance should satisfy ample space for safe operation and installation.

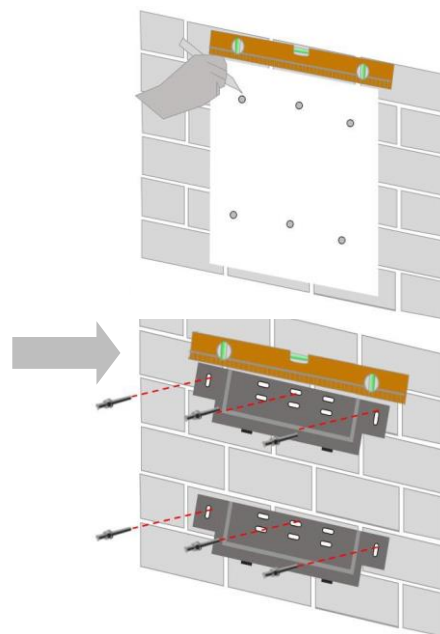

## ➤ STEP2 Install the Smart gateway bracket A2

**⚠ NOTE:** Select the suitable M8 (or similar) bolt/screw to mount the Bracket A2 on different types of walls.

e.g. minimum length M8\*3" anchor bolts are used for concrete walls and minimum thread length 1-1/2" bolt/screws are used for wooden walls.

- Remove the Smart gateway drill template.
- Use the socket wrench to remove washers and nuts and install the bracket A2 with M8 bolts or 1-1/2" wood screws with washers on the Wall.
- Use the level tool to measure bracket A2 to measure its level and tighten the anchor nuts to specified values. (Ref. to Appendix-Torque Values)

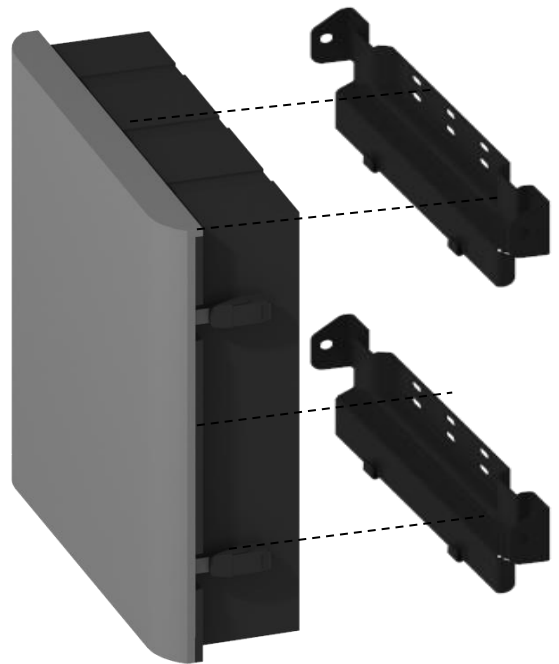

*Install bracket A2 on wall*

## ➤ STEP3 Install the Smart gateway bracket A1

- Attach the bracket A1 on the back side of the smart gateway, and tighten it with Bolts (M5\*0.55" ).

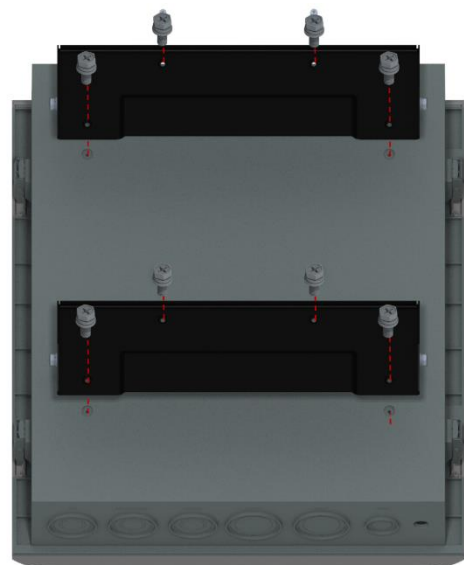

➤ **STEP4 Final installation step for the Smart gateway**

- a. Carefully hang Bracket A1 on the Bracket A2 hooks.
- b. Fasten the Brackets A1 and A2 with bolts (M8\* 0.63" ).
- c. Check with the level tool to make sure the Smart gateway is leveled, adjust it if it is not level. After that, tighten all the bolts to the specified torque values. (Ref. to Appendix-Torque Values).

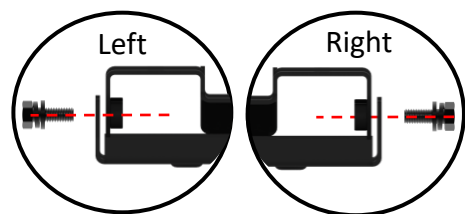
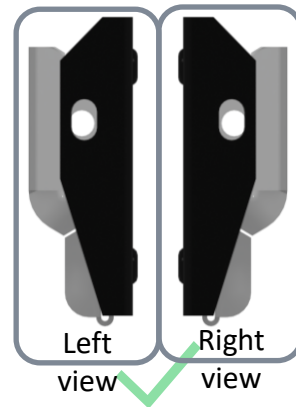

*Tighten and check bracket A installations*

## WIRING & COMMISSIONING

This section introduces the EP Cube system wiring connections and commissioning steps.

### **WARNING :**

The EP Cube does not require any annual maintenance. If a malfunction or hidden error occurs, the products may only be installed, repaired, or replaced by the EP authorized personnel for safety and warranty purposes.

For personal protection and property safety, please read the safety chapter and ensure complete compliance during the entire installation process.

### 1. EP Cube System wiring

This section introduces the EP Cube system wiring process.

#### Preparation

According to the formulated EP Cube system configuration and wiring scheme:

- Prepare the appropriate quantity and dimensions of electrical and installation materials.
- Prepare the appropriate auxiliary tools and equipment.

#### Tools & Materials



*Drill Set (with 3/8" drill bit)*

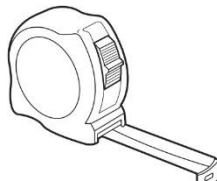

*Tape Measure*

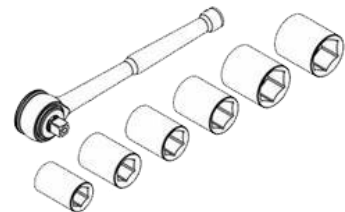

*Socket Wrench Set*

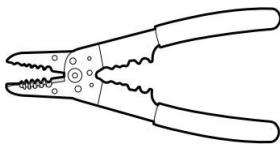

*Wire Stripper*



*Multimeter*

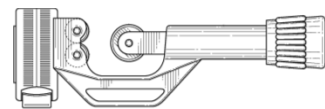

*Pipe Cuter*



*Power circuit wire*



*Control wire*



*Ground wire*

## Start wiring & connection

**⚠ CAUTION:** Please ensure all circuit breakers are turned off. Wear the appropriate PPE before beginning.

### A. Wiring from the solar panels to the Hybrid

#### ➤STEP1 Open the Hybrid inverter for wiring

- a. Remove the Hybrid inverter panel covers:
  - Open the two Hybrid panel latches and remove the inverter cover.
  - Use the socket wrench to remove the nuts and inverter dead front cover.
  - Use the socket wrench to remove the two port caps on the left side of the Hybrid for the conduit.

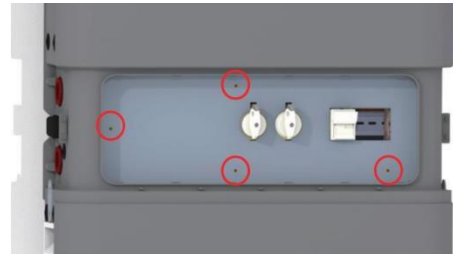

#### ➤STEP2 Connect PV wiring cables to Hybrid inverter

- a. Prepare the conduit for PV wiring connections with the Hybrid.
  - Install a threaded adapter or cable gland to tighten up the conduit to Hybrid. (Adapter OD thread must be NPT 3/4").

**⚠ NOTE:** Each set of PV cables, PV+ and PV-, must connect to the correct terminal of the Hybrid.

- b. Pass the PV cables through the conduit and connect to the designated terminal blocks in the Hybrid inverter. (Ref. Picture 1)
- Use a flat-head screwdriver to press the PV- and PV+ terminal blocks to open and insert cables and then release to terminate the PV wires in place.

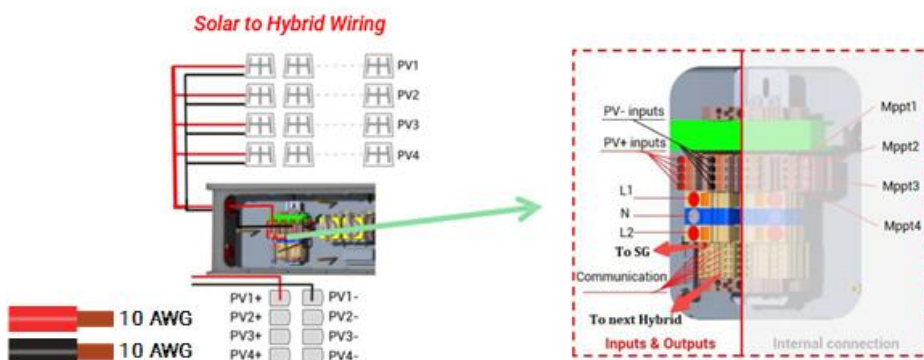
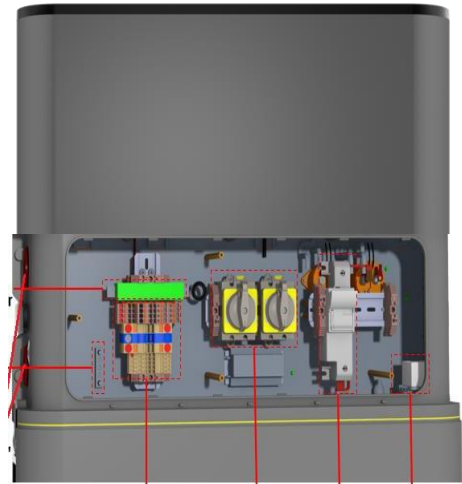

Picture 1.

## B. Wiring from the Hybrid to Smart Gateway

### ➤ STEP1 Open the Smart gateway for wiring

a. Remove the Smart gateway panel covers:

- Open the four smart gateway panel latches and remove the cover.
- Use the socket wrench to remove nuts and remove the smart gateway dead front cover.

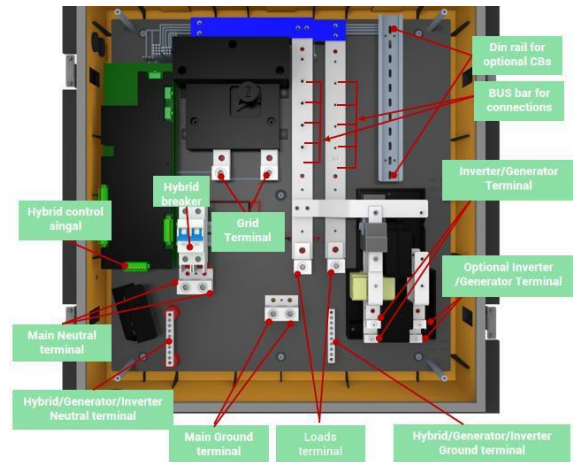

### ➤ STEP2 Connect Hybrid wires to Smart Gateway

a. Prepare the conduit for the hybrid power cables to the Smart gateway hybrid breaker and other terminals.

b. Pass the Hybrid cables through the conduit to connect to the Smart gateway hybrid breaker: ( Ref. Picture 3 )

- Follow the local standards to select different colors for AWG 6 cable for L1, N, L2, and ground between hybrid and the smart gateway.
- Strip the wire ends using a wire stripper, use a flat-head screwdriver to unscrew the breaker terminals, then insert the cables and fasten the screws.
- Refer to picture 2 for wiring the AC output L1, N, L2, and ground cable between the Hybrid and Smart gateway breaker.

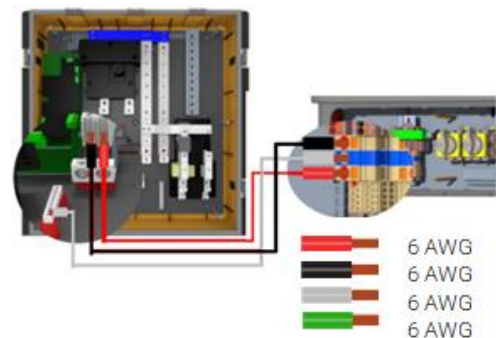

**Hybrid to Smart gateway breaker AC wiring**

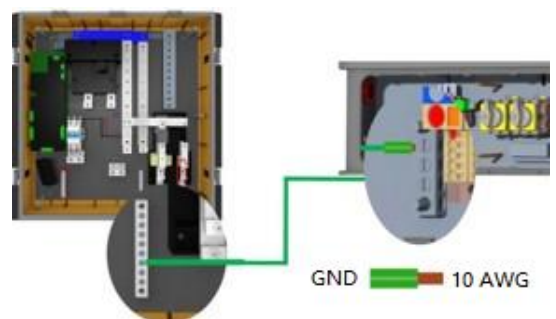

**Hybrid to Smart gateway Ground wiring**



c. Pass the Hybrid signal wires through the conduit to connect to the Smart gateway CAN & RESS terminal: (Ref. Picture 2 & 3)

- Select at least a 5-in-1 sheathed shielded signal cable for the Hybrid and Smart gateway signal wiring.
- Strip the wire ends with a wire stripper, and use a flat-head screwdriver to press the terminal to insert and lock the signal wires.
- Refer to picture 2 for wiring the L2, H2, GND, PWM, and HJA terminals between the Hybrid and Smart gateway.

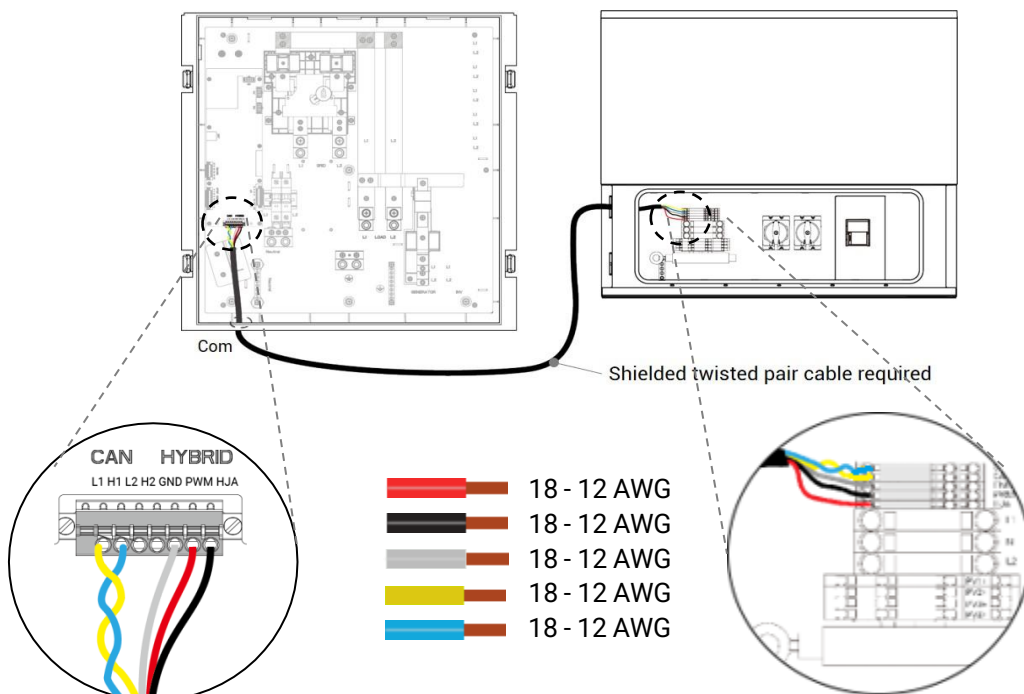

**Picture 2.**

**Smart gateway to Hybrid communication wiring**

d. Open the Smart gateway COMS and the Hybrid port to mount conduits: (Ref. Picture 3)

- Drill into the Smart gateway bottom "COMS port" and "HYBRID port" with a hole saw for cable gland installation.
- Install the cable gland and tighten up the conduit to the Smart gateway.
- Install a threaded adapter or cable gland to tighten up the conduit to the Hybrid. (Adapter OD thread must be NPT 3/4").
- Affix the conduit onto the wall with the proper distance between clamps.

**NOTE:**

- Knockout for Hybrid at the bottom of the smart gateway can be used to install a cable gland with a maximum diameter of 2-1/4" or less.
- Knockout for COMS at the bottom of the smart gateway can be used to install a cable gland with a maximum diameter of 1-1/2" or less.

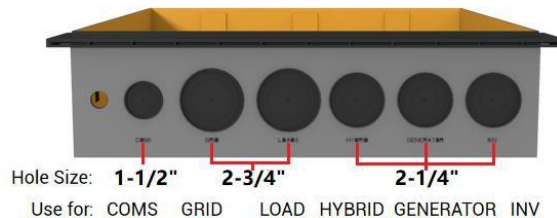

Picture 3.

### C. Wiring of Grid and Load Side connections

**CAUTION:**

- Ensure all circuit breakers are turned off, and PPE is properly worn before getting started.
- Ensure that the property main breaker for the Grid connection is turned off and protected with Lockout/Tagout.
- For partial home backup, between the backup loads and the Smart gateway load terminal, there must be a power panel to combine all load connections, then this panel can connect to the Smart gateway load terminal.
- All cables between equipment need to be wired through conduits, The conduits must be affixed to the wall with clamps at the appropriate distance.

For whole home backup configuration :

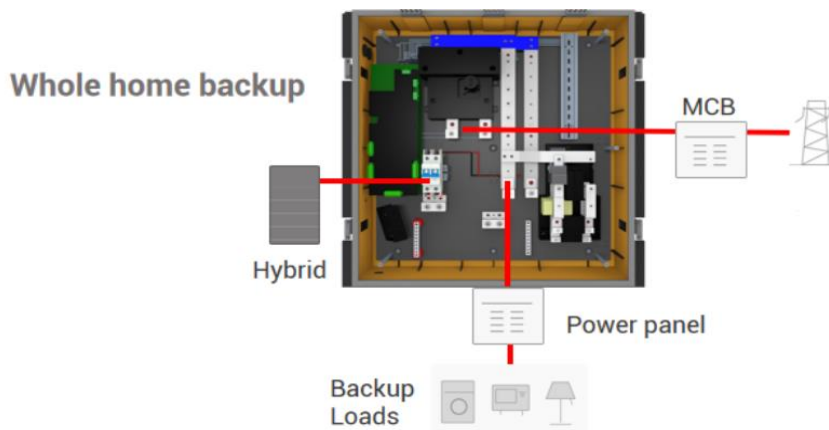

Picture 4.

## ➤ STEP1 Wiring Connection of Grid

a. Prepare the conduit for the Grid power cable connection between the Grid power panel or the main breaker and Smart gateway, and install a cable gland to install the conduit to the smart gateway:

- Select a drill with an appropriate hole saw, and drill the knockout for Grid on the bottom of the Smart gateway to install the cable gland. (Ref. to Picture 3.)
- Install the cable gland and tighten up the conduit to the Smart gateway.

**⚠ NOTE:** Knockout for the grid at the bottom of the Smart gateway can be used to install a cable gland with a maximum diameter of 2-3/4" or less.

b. Pass the Grid power cable through the conduit and connect it to the Smart gateway Grid terminal. (Ref. to Picture 5.)

## ➤ STEP2 Wiring Connection of Load

a. Prepare the conduit for the Load power cable connection between the backed up loads power panel and the smart gateway, then install a cable gland to tighten the conduit to the smart gateway:

- Select a drill with an appropriate hole saw and drill the knockout for the load on the bottom of the Smart gateway to install the cable gland. (Ref. to Picture 3.)
- Install the cable gland and tighten the conduit to the smart gateway.

**⚠ NOTE:**

- Knockout for the load at the bottom of the Smart gateway can be used to install a cable gland with a maximum diameter of 2-3/4" or less.
- Please ensure the load power cable is well protected when combined with the grid power cable in one conduit.

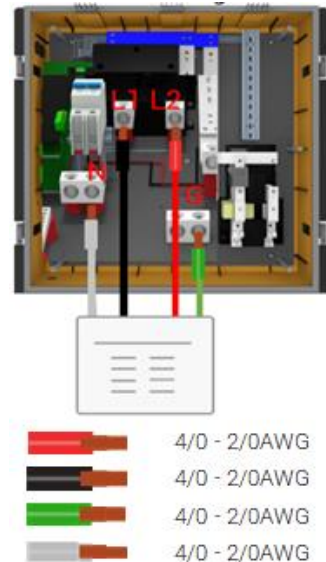

Picture 5.

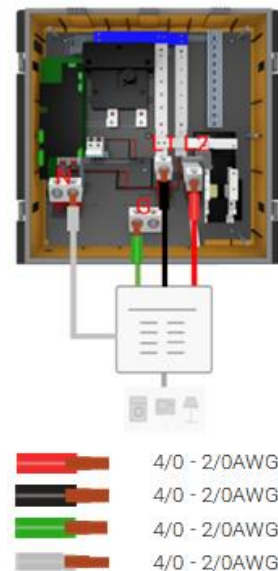

Picture 6.

- c. Pass the load power cable through the conduit and connect it to the smart gateway load terminal. (Ref. to Picture 6.)
- b. Connect the load power cable and the backup load appliances on the backup load power panel.

## For partial home backup configuration:

**⚠ NOTE:** In this configuration the “CT-Kit” is optional.

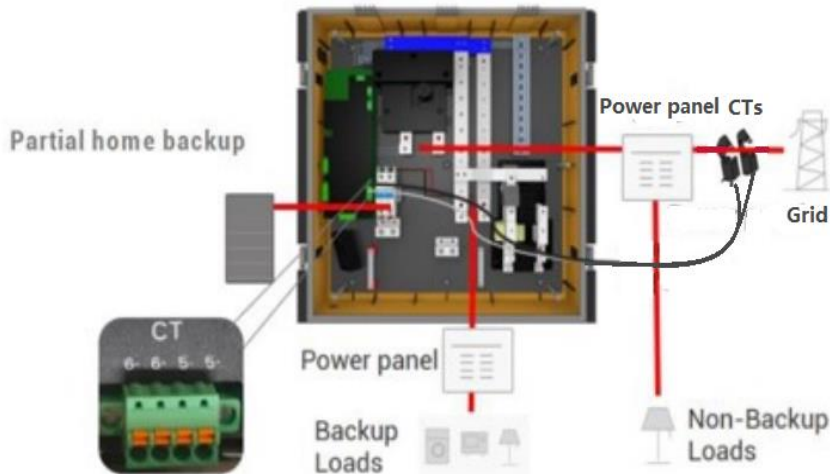

### ➤ STEP1 Wiring of Grid

a. Prepare the conduit for the Grid power cable connection between the Grid power panel or main breaker and the smart gateway. Install a cable gland to tighten the conduit to the smart gateway:

- Select a drill with an appropriate hole saw, and drill the knockout for Grid on the bottom of the Smart gateway to install the cable gland. (Ref. to Picture 3.)
- Install the cable gland and tighten the conduit to the Smart gateway.

**⚠ NOTE:** Knockout for the grid at the bottom of the Smart gateway can be used to install a cable gland with a maximum diameter of 2-3/4" or less.

b. Pass the Grid power cable through the conduit and connect it to the Smart gateway Grid terminal. (Ref. Picture 5.)

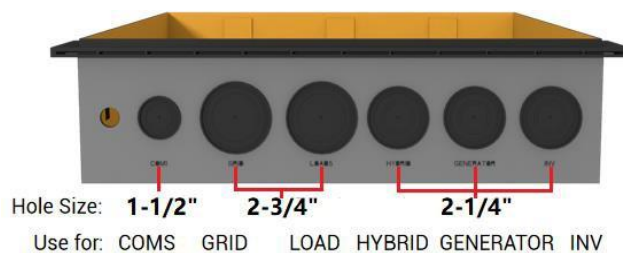

## ➤ STEP2 Wiring of Load

a. Prepare the conduit for the backup load power cable connection between the backup load power panel and the Smart gateway. Install a cable gland to tighten the conduit to the Smart gateway:

- Select a drill with an appropriate hole saw, and drill the knockout for the load on the bottom of the Smart gateway to install the cable gland. (Ref. to Picture 3.)
- Install the cable gland and tighten the conduit to the Smart gateway.

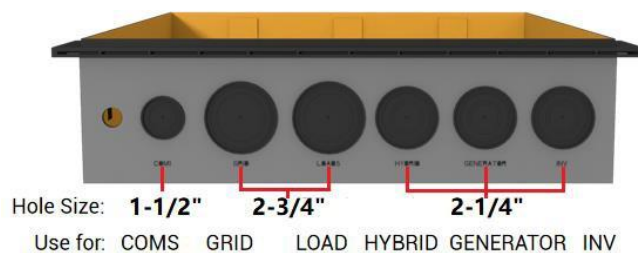

### ⚠ NOTE:

- Knockout for the load at the bottom of the Smart gateway can be used to install a cable gland with a maximum diameter of 2-3/4" or less.
- Ensure the load power cable is well protected when both the grid power cable and the backup load cable share the same conduit.
- Pass the load power cable through the conduit and connect it to the smart gateway load terminal. (Ref. to Picture 5.)
- Connect the load power cable and backup load appliances to the backup load power panel.

## Wiring of other components

### CAUTION:

- Please ensure all circuit breakers are turned off and PPE is properly worn before getting started.
- Please ensure that the property main breaker of the Grid is turned off and protected with Lockout/Tagout.

### D. Wiring of emergency stop (Optional)

a. Remove the press-fit jumper on the smart gateway PCB board connector "CON8e" between terminals 1+ & 1-

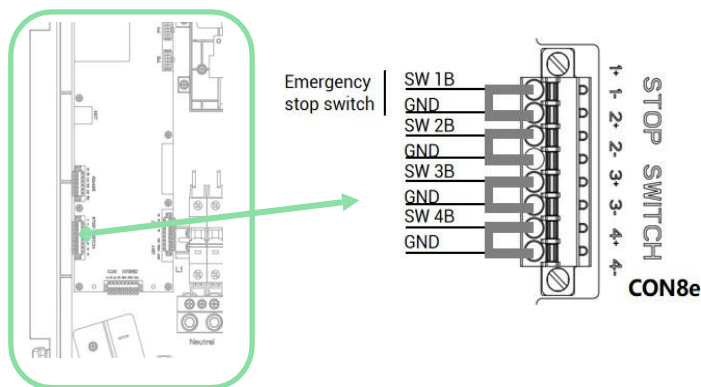

*Smart gateway PCB board*

b. Connect emergency stop wires to terminals 1+ & 1-. Do the running test at least once during the system commissioning and debugging.

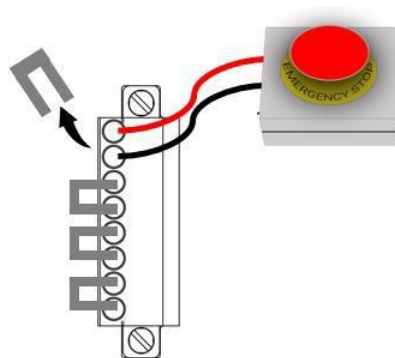

## E. Wiring of "CT-Kit" ( Optional )

**⚠ NOTE:** The CT's direction shall be from grid to MCB (  $k \rightarrow L$  ), otherwise the system will not work correctly.

a. If needed, pass the "CT-Kit" signal wires through the Grid power cable conduit and connect it to the Smart gateway CT terminal. (Ref. to Picture 7.)

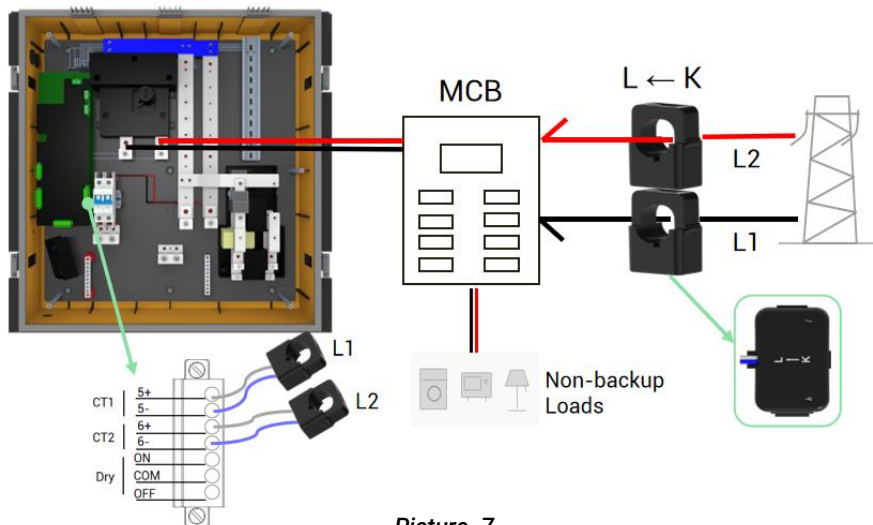

Picture 7

## F. Wiring of Hybrid inverter Mating connector

**⚠ CAUTION:**

- Do not dock the mating connector when the battery fuse is still connected to prevent electric shock.

a. Pull down to open the Battery fuse to disconnect the internal connection of the battery fuse.

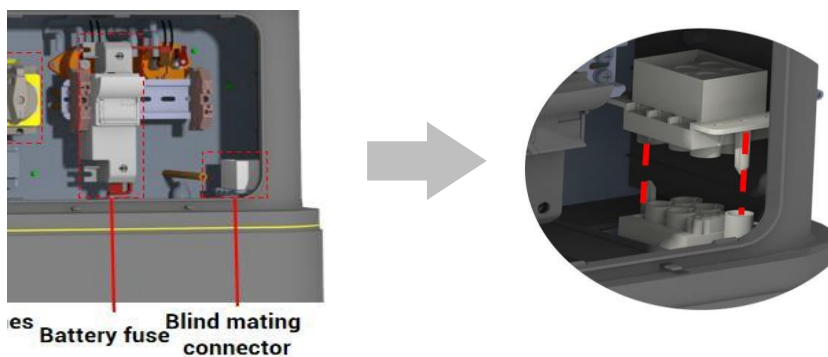

**Dock the Hybrid Inverter Mating Connector**

- b. Dock the Hybrid inverter mating connector as picture shows.
- c. Push back to close the Battery fuse.

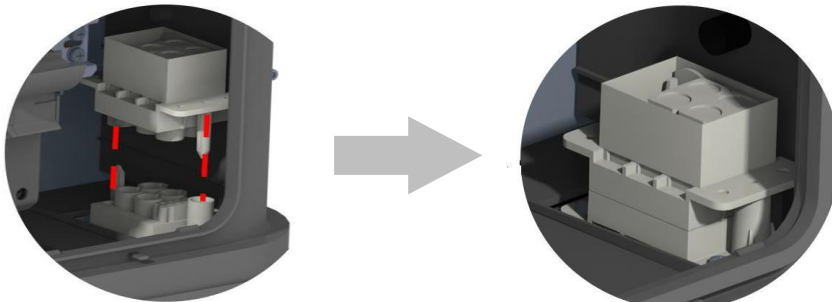

## 2. EP Cube System commissioning

This section introduces the EP Cube system's initial commissioning and operating process.

### A. EP Cube Startup

#### **CAUTION:**

- Please ensure PPE is properly worn before getting started.
- For the initial startup, the smart gateway must have AC electrical power supply, otherwise there will be no start-up signal generated by the smart gateway to the Hybrid system.
- EP Cube commissioning can only select a working module, no other decommissioning or functions are needed for on-site services.

- a. Install all equipment covers and ensure no live electrical components will be exposed during operation.
- b. Turn on the smart gateway circuit breakers and make sure there are no errors.
- c. Switch on the smart gateway and the EP Cube Hybrid via the power button as shown in the pictures. Ensure equipment and load output is normal.

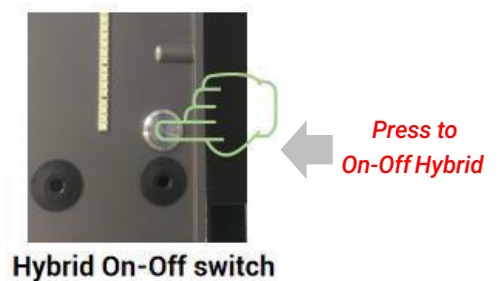



 **CAUTION:** EP Cube's maximum starting load capability is 118A LRA. Authorized installers should analyze and ensure the site is compliant with this requirement.

Status	LED Indicator	Message
Normal	Solid	Normal Operation
Alarm	Flash per 2s	Low Power Alarm
Fault	Quick flash per 0.5s	Malfunction or Warning

c. Open the EP Cube app and connect with EP Cube via Bluetooth connection. Connect to the internet, download, and update the latest system firmware version.

d. Select the operation mode, then turn on the Grid power control. Verify in the app and ensure that EP Cube is operating without error.

e. Turn on the PV input and verify in the app that the whole EP Cube system is operating well with all energy sources - PV, Grid, Generator, and other brand inverters or household appliances if any.

f. Cover and lock the Hybrid and Smart gateway dead-front covers, panel covers, and side covers.

## **B. Registration and finish**

g. Assist the property owner with downloading the EP Cube app and:

- Register an account and connect to the EP Cube System.
- Give the user an introduction to the EP Cube product usage and app operation settings.

h. Clean the site and perform a final inspection to ensure all tasks are completed.

i. Complete the user confirmation and upload photos to close the work order according to the service process requirements.

## IMPORTANT SAFETY INSTRUCTIONS

For personal protection and property safety, please read this section carefully and strictly implement its contents before installing and using the product. EP company is not liable for any loss caused due to violation of the instructions in this manual.

### 1. Safety Notice

In the event of any threat to health or safety, always begin with the following two steps before taking any other precautionary measures:

1. Immediately contact the fire department or other relevant emergency response team.
2. Notify all people who might be affected and ensure that they are able to evacuate this area.

 **DANGER:** Indicates the situation which, if not avoided, will lead to death or serious injury.

 **CAUTION:** Indicates the situation which, attention is necessary to avoid potential injury or property damage.

 **DANGER:**

- EP Cube products are equipped with a battery that is heavy! Use of lifting equipment is recommended. Do not stack the unpacked products to avoid irreversible damage.
- It is prohibited to touch the EP Cube internal components when it's running. Ensure that the power switch and the breaker of EP Cube are always turned off prior to all installation, replacement, and maintenance processes.
- Do not attempt to open, disassemble, tamper with, or modify the EP Cube without prior written approval from the EP company.
- Do not squeeze, impact or puncture the battery.
- Do not operate the EP Cube out of the specified conditions and requirements. In addition, do not stand, lean on or sit on the product.
- Do not place the EP Cube or its components in water or other liquids, or expose EP Cube to flammable gases, other corrosive substances, and heating sources. Otherwise please refer to applicable local codes and UL 9540.

 **CAUTION:**

- The transportation, installation, and commissioning of the EP Cube must be carried out under the specified conditions. Do not expose EP Cube to extreme conditions during these periods.
- EP Cube can only be installed, repaired, replaced, and maintained by the EP authorized personnel for safety and warranty purposes. PPE must be worn during any operations.
- Do not place foreign objects on top of the product or insert inside the product.
- Ensure there is enough space around EP Cube for ventilation.

- Be careful to protect the EP Cube from impact when installing it in a garage or near vehicles. If possible, install the EP Cube on a side wall or above the height of vehicle bumpers.
- The packaged battery modules are forbidden to be stacked more than the specified quantity. Do not reverse the polarity of the battery during connections.
- High temperatures and heating equipment, or sources of extreme heat, may cause the battery to go in a thermal runaway, thereby exceeding the ignition point of its material, risking causing a fire. Please refer to applicable local residential building requirements, and fire and energy storage system installation codes.
- Do not try reverse engineering, decompile, disassemble, adapt, implant, or perform other derived operations on the EP Cube firmware.
- Do not study the internal implementation of the product firmware source code and steal intellectual property rights.

## 2. Personal Protective Equipment

Wear the following safety equipment properly to perform installations. Installers must meet the relevant requirements of standards, such as IEC, OSHA, State, and Local laws.

- Safety goggles
- Ear plugs
- Insulated gloves
- Safety gloves
- Safety shoes



## APPENDIX

### 1. Torque Values

#### A. Torque values for fasteners

Torque Values Table • N/m (lbs/inch)

Bolt Dia.(mm)	PCB Panel bolts	Countersunk bolts	Other bolts
M3	0.5 (4.5)	- N/A -	- N/A -
M4	1.1 (10)	2.2 (20)	
M5	- N/A -	4 (35)	6 (55)
M6		7 (60)	9.5 (85)
M8		- N/A -	25 (220)

#### B. Torque values for wires

Torque Values Table • N/m (lbs/inch)

Wire size AWG/kcmil	Slotted head no. 10 and larger		Hexagonal head	
	Slot width – 0.047” or less and slot length 1/4” or less	Slot width – over 0.047” or slot length-over 1/4”	Split-bolt connectors	Other connectors
18-10	2.3 (20)	4.0 (35)	9.0 (80)	8.5 (75)
8	2.8 (25)	4.5 (40)	9.0 (80)	8.5 (75)
6-4	4.0 (35)	5.1 (45)	18.6 (165)	12.4 (110)
3	4.0 (35)	5.6 (50)	31.1 (275)	16.9 (150)
2	4.5 (40)	5.6 (50)	31.1 (275)	16.9 (150)
1	-	5.6 (50)	31.1 (275)	16.9 (150)
1/0 – 2/0	-	5.6 (50)	43.5 (385)	20.3 (180)